

## ■ Gewindestange DIN 976-1 M10 x 3.000 mm gvz FK 4.6

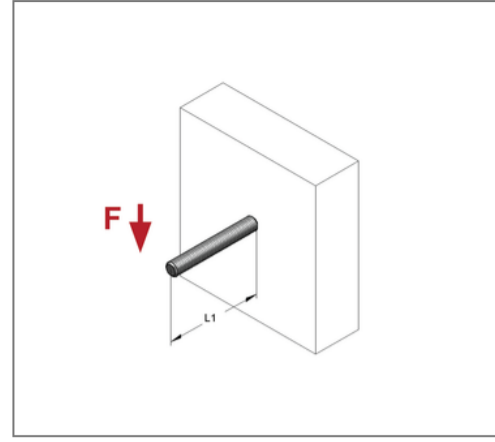
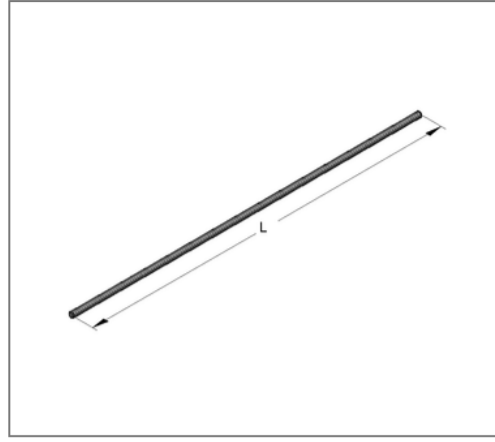
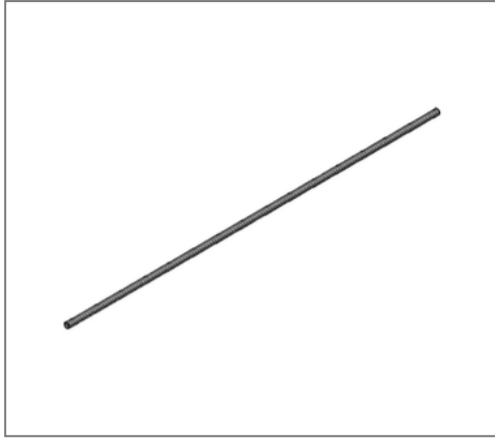

### Kaufmännische Details

Artikelnummer	0730505
EAN/GTIN	4250928416544
VPE	25 St
Bund	25 St
Mengeneinheit	St
Gewicht	1,53 kg/St
Rabattgruppe	05-073
Preiseinheit	1

### QR Code



### Technische Daten

Material	Stahl
Oberfläche	galvanisch verzinkt
Festigkeitsklasse	4.6

### Produktdetails

Gewinde	M10
Länge	3000 mm
zul. Zuglast FWD 30	1,27 kN
zul. Zuglast FWD 60	0,72 kN
zul. Zuglast FWD 90	0,55 kN
zul. Zuglast	14,2 kN