

■ Insulated fixpoint HV 1 139,7 mm Insulation 40 mm Shell length 148 mm

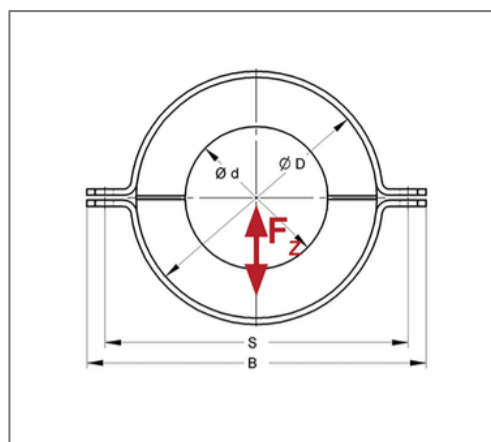
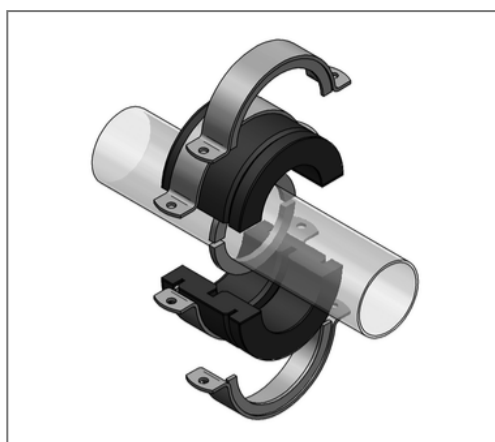
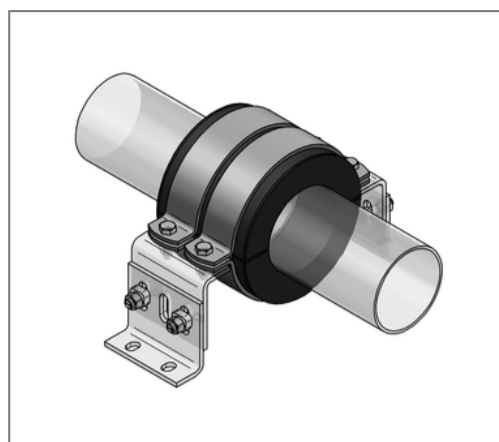

Commercial details

Part no.	698400140
EAN/GTIN	4250928441164
Packing unit	1 pcs
Quantity unit	pcs
Weight	5,58 kg/pc
Product group	03-698
Price unit	1

QR code



Specification

Application area	Insulated fixpoint mounting of chilled water pipes of steel
Specification	PUR (with natural rubber on front ends) High water vapor diffusion resistance and low thermal conductivity. Acc. AGI the requirements
Delivery	2 x half shell with slot for inner and outer split ring 2 x inner split ring for welding to steel pipe 4 x outer split ring for fixation on substructure

Technical data

Material	PU
min. temperature resistance	-50 °C
max. temperature resistance	105 °C
Density	200 kg/m ³

Product details

Insulation thickness	40 mm
Outer pipe diameter	139,7 mm
Hole distance S	271 mm
Thermal conductivity	0,037 W/mK
Length shell L	148 mm
Width outer split ring B	300 mm
Recommended fixpoint bracket [type]	HV1
load F_Y	4,5 kN
load F_Z	9,2 kN