

■ Connector SIMA G DN 80 OD 83 mm

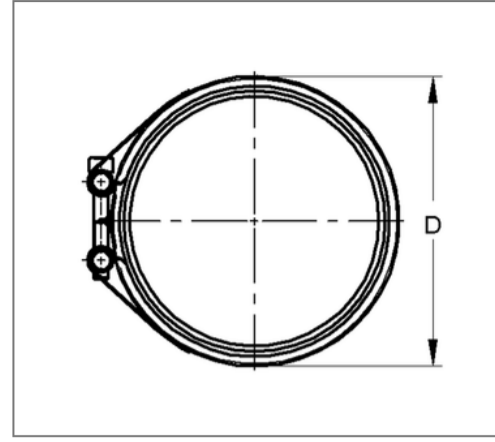
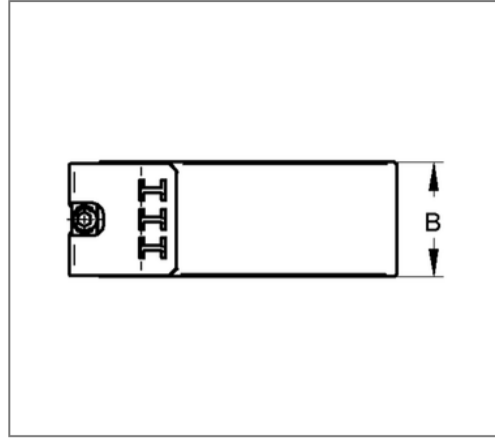
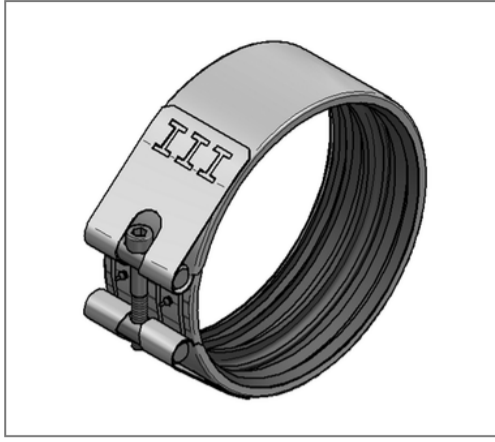

Commercial details

Part no.	4470080
EAN/GTIN	4250928439352
Packing unit	50 pcs
Quantity unit	pcs
Weight	0,201 kg/pc
Product group	03-447
Price unit	1

QR code

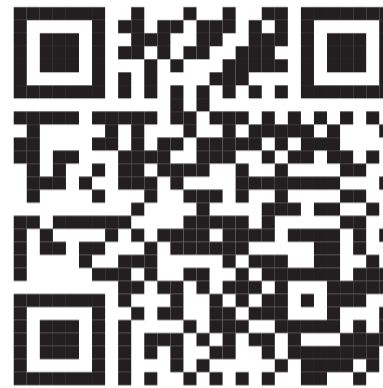

Certification



Specification

Application area	plug connector for cast iron pipe and fittings
Number of closure screws	1
Strength class	8.8
max. pressure load	0,5 bar
Closure part connection	Seamed joint

Technical data

Material	Steel
Material type	S320
Material turnbuckle	Steel
Material type clamp lock	9 S 20
Surface turnbuckle	Zinc-Aluminium
Material cuff	Rubber EPDM
Surface	Zinc-Aluminium
min. temperature resistance	-35 °C
max. temperature resistance	80 °C
Colour cuff	black
Class	B2
Tightening torque	6 Nm

Product details

Width D	95 mm
Outer pipe diameter	83 mm
Width pipe clamp strap B	46 mm
Nominal pipe diameter	80 mm
Screw type DIN 911	hexagon socket, M6 (SW 5)
Connector type	Plug connector