

## ■ Grip connector SIMA-Cramp DN 50 OD 58 mm two-part

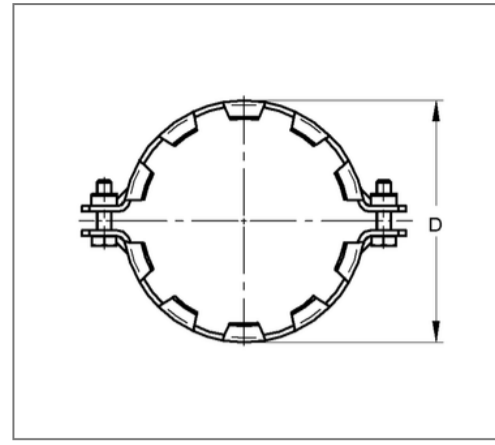
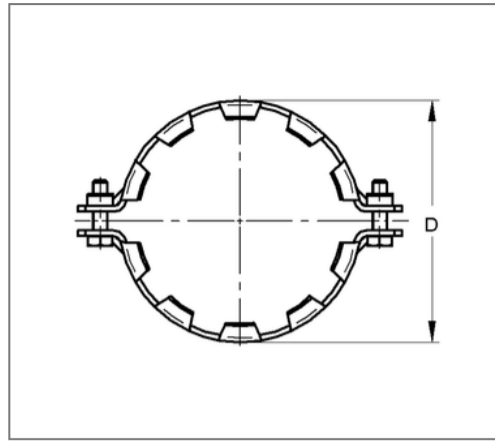
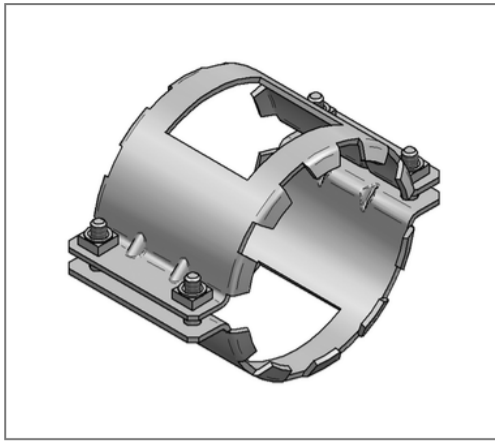

### Commercial details

Part no.	4472500
EAN/GTIN	4250928439406
Packing unit	20 pcs
Quantity unit	pcs
Weight	0,447 kg/pc
Product group	03-448
Price unit	1

### QR code



### Certification

22 1130 3 94  
MPA NRW

### Technical data

Material	Steel
Material type	S235
Surface	galvanized

### Specification

Application	grip connector without sleeves, drain pipes in area
Specification	connection with connector SIMA >G< two-part

### Product details

Outer pipe diameter	58 mm
Length S	113 mm
Tightening torque	50 Nm
Width pipe clamp strap B	79 mm
max. pressure load	5 bar
Nominal pipe diameter	50 mm
Height D	75 mm