

## ■ Grip connector SIMA-Cramp DN 70 OD 78 mm two-part

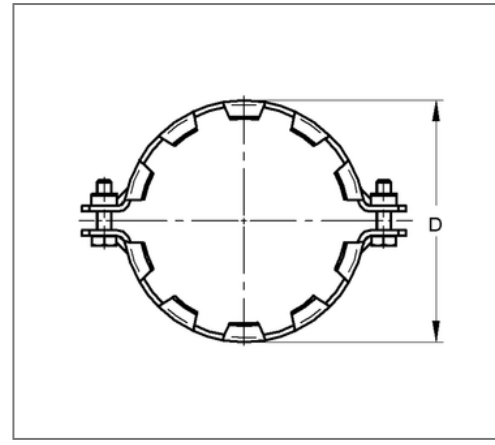
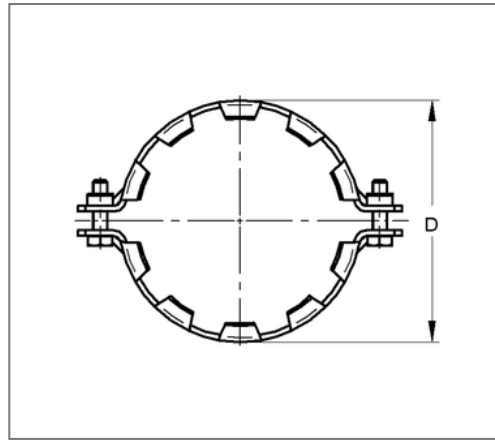
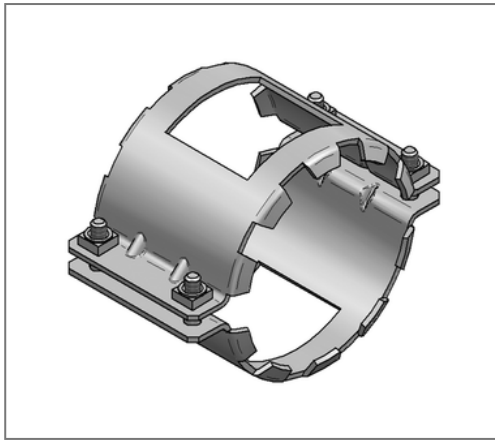

### Commercial details

Part no.	4472705
EAN/GTIN	4250928439413
Packing unit	20 pcs
Quantity unit	pcs
Weight	0,576 kg/pc
Product group	03-448
Price unit	1

### QR code



### Certification

22 1130 3 94  
MPA NRW

### Technical data

Material	Steel
Material type	S235
Surface	galvanized

### Specification

Application	grip connector without sleeves, drain pipes in area
Specification	connection with connector SIMA >G< two-part

### Product details

Outer pipe diameter	78 mm
Length S	134 mm
Tightening torque	15 Nm
Width pipe clamp strap B	92 mm
max. pressure load	5 bar
Nominal pipe diameter	70 mm
Height D	99 mm