

## ■ Spring hanger FH 1 - 600 F 0 - 619 N max. spring deflection 30 mm

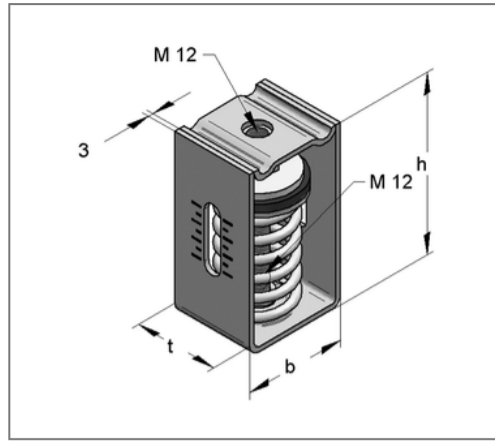
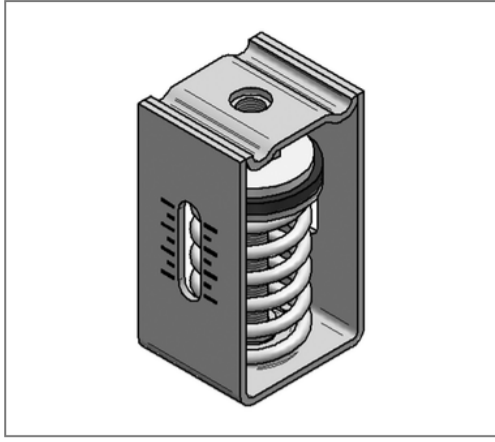

### Commercial details

Part no.	0794060
EAN/GTIN	4250928419095
Packing unit	1 pcs
Quantity unit	pcs
Weight	0,551 kg/pc
Product group	03-079
Price unit	1

### QR code



### Specification

Application	Spring isolators as flexible pipe hangers or for elastic mounting of aggregates.
Number of springs	1

### Technical data

Material	Steel
Material type	S235
Surface	galvanized

### Product details

Connection	M12
Width b	60 mm
Height h	105 mm
Length t	50 mm
Spring rate	20,62 N/mm
max. spring deflection	30 mm
max. load range	619 N