

■ Spring hanger FH 1 - 1000 F 0 - 1006 N max. spring deflection 32 mm

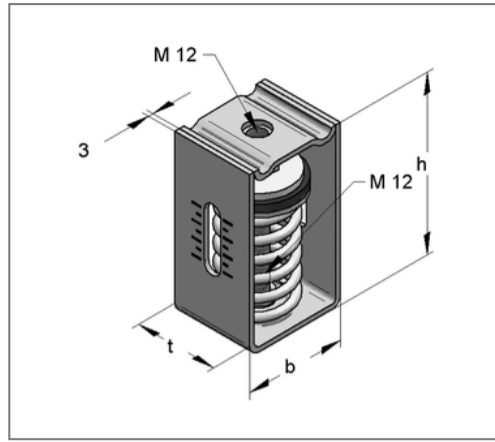
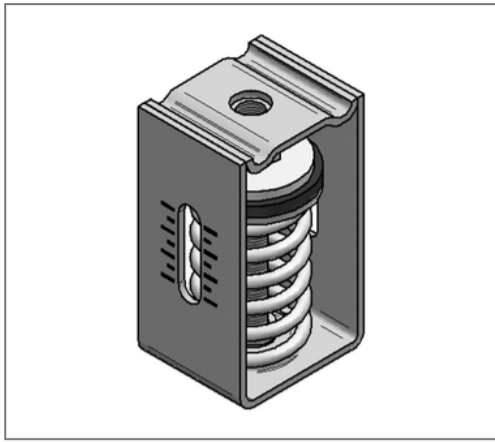

Commercial details

Part no.	0794100
EAN/GTIN	4250928419101
Packing unit	1 pcs
Quantity unit	pcs
Weight	0,575 kg/pc
Product group	03-079
Price unit	1

QR code



Specification

Application	Spring isolators as flexible pipe hangers or for elastic mounting of aggregates.
Number of springs	1

Technical data

Material	Steel
Material type	S235
Surface	galvanized

Product details

Connection	M12
Width b	60 mm
Height h	105 mm
Length t	50 mm
Spring rate	34,43 N/mm
max. spring deflection	32 mm
max. load range	1006 N