

■ Spring hanger FH 1 - 1300 F 0 - 1289 N max. spring deflection 31 mm

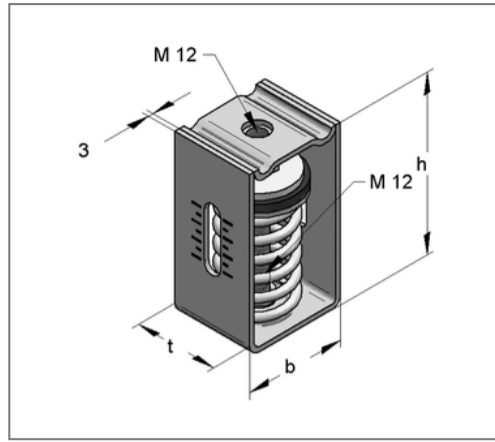
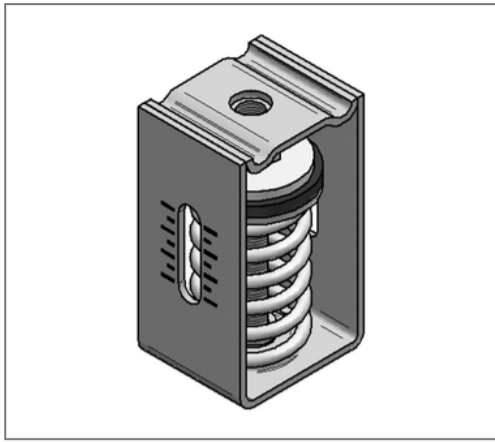

Commercial details

Part no.	0794130
EAN/GTIN	4250928419118
Packing unit	1 pcs
Quantity unit	pcs
Weight	0,950 kg/pc
Product group	03-079
Price unit	1

QR code



Specification

Application	Spring isolators as flexible pipe hangers or for elastic mounting of aggregates.
Number of springs	1

Technical data

Material	Steel
Material type	S235
Surface	galvanized

Product details

Connection	M12
Width b	80 mm
Height h	130 mm
Length t	60 mm
Spring rate	41,58 N/mm
max. spring deflection	31 mm
max. load range	1289 N