

## ■ Spring hanger FH 1 - 3000 F 0 - 3084 N max. spring deflection 23 mm

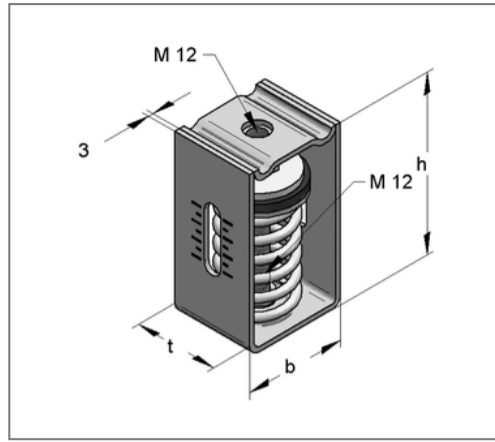
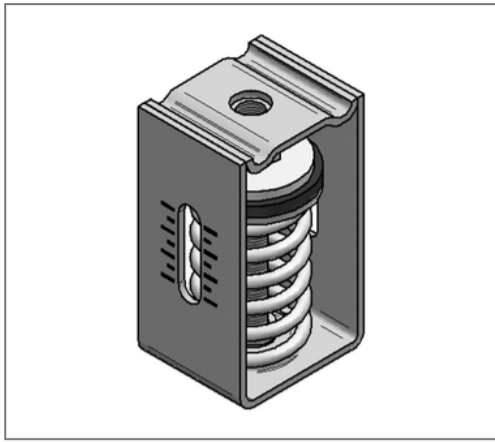

### Commercial details

|               |               |
|---------------|---------------|
| Part no.      | 0794300       |
| EAN/GTIN      | 4250928419132 |
| Packing unit  | 1 pcs         |
| Quantity unit | pcs           |
| Weight        | 1,19 kg/pc    |
| Product group | 03-079        |
| Price unit    | 1             |

### QR code



### Specification

|                   |  |
|-------------------|--|
| Application       | Spring isolators as flexible pipe hangers or for elastic mounting of aggregates. |
| Number of springs | 1  |

### Technical data

|               |            |
|---------------|------------|
| Material      | Steel      |
| Material type | S235       |
| Surface       | galvanized |

### Product details

|                        |            |
|------------------------|------------|
| Connection             | M12        |
| Width b                | 80 mm      |
| Height h               | 130 mm     |
| Length t               | 60 mm      |
| Spring rate            | 134,1 N/mm |
| max. spring deflection | 23 mm      |
| max. load range        | 3084 N     |