

■ Spring hanger FH 2 - 6000 plus F 0 - 6044 N max. spring deflection 23 mm

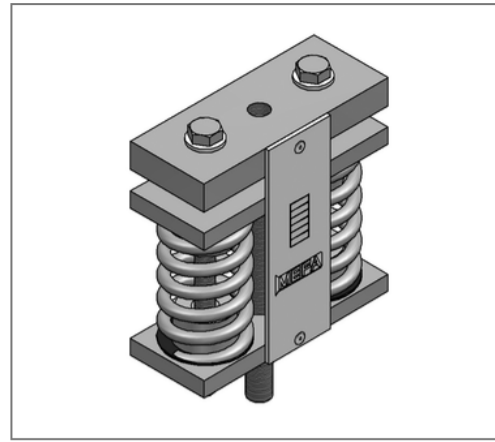
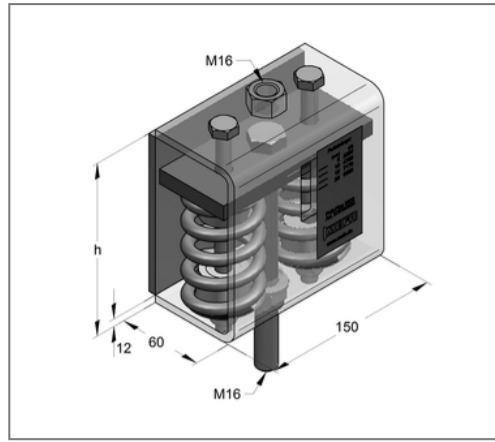
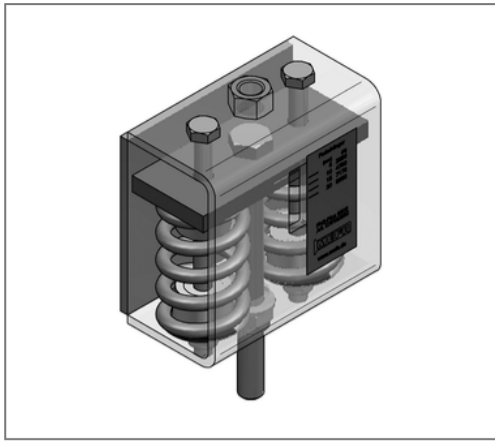

Commercial details

Part no.	079170600
EAN/GTIN	4250928449207
Packing unit	1 pcs
Quantity unit	pcs
Weight	5,11 kg/pc
Product group	03-079
Price unit	1

QR code



Specification

Application	Spring isolators as flexible pipe hangers or for elastic mounting of aggregates.
Number of springs	2

Technical data

Material	Steel
Material type	S235
Surface	galvanized

Product details

Connection	M16
Width b	80 mm
Height h	140 mm
Length t	140 mm
Spring rate	268,6 N/mm
max. spring deflection	23 mm
max. load range	6044 N