

## ■ Sliding plate 250 x 200 x 8 Connection 2 x 1/2"

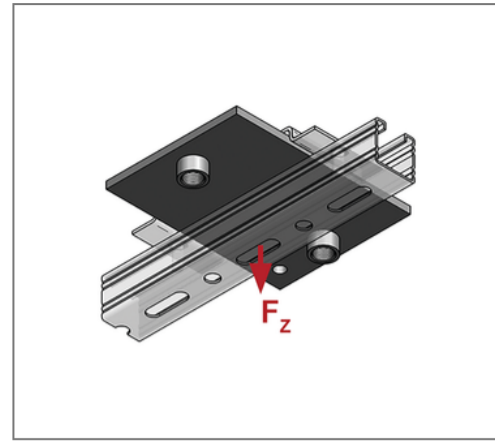
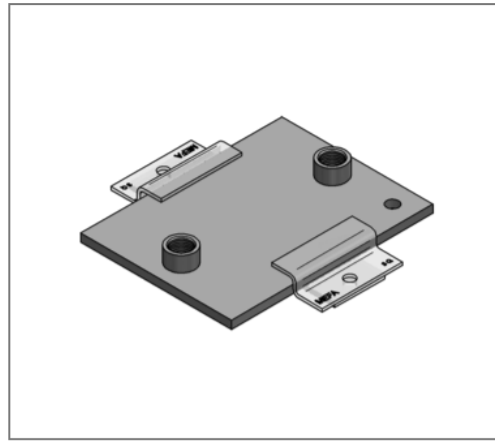

### Commercial details

Part no.	0771707
EAN/GTIN	4250928418340
Packing unit	1 pcs
Quantity unit	pcs
Weight	3,26 kg/pc
Product group	04-077
Price unit	100

### QR code



### Technical data

Material	Steel
Material type	S235
Surface	galvanized

### Product details

Connection	1/2"
Length L	250 mm
Width B	200 mm
Thickness S	8 mm
load $F_z$	4,2 kN
Axial dimension a	25 mm
Number of connections	2
max. sliding distance axial hanging	120 mm
max. sliding distance axial standing	200 mm

### Remark

Note	delivery time on demand
------	-------------------------