

■ Sliding plate 300 x 200 x 10 Connection 2 x 1"

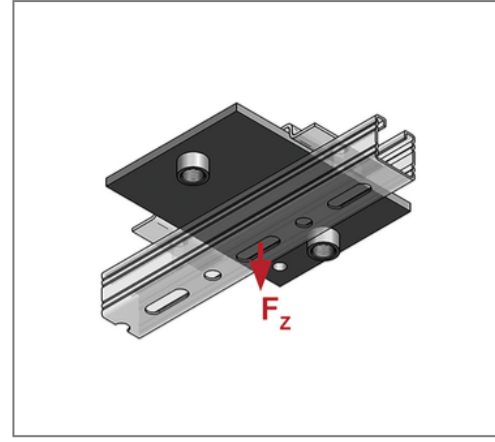
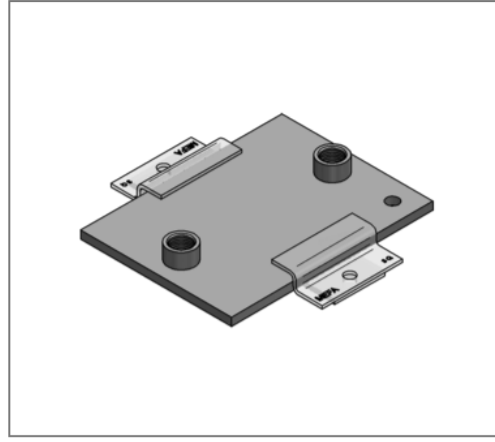
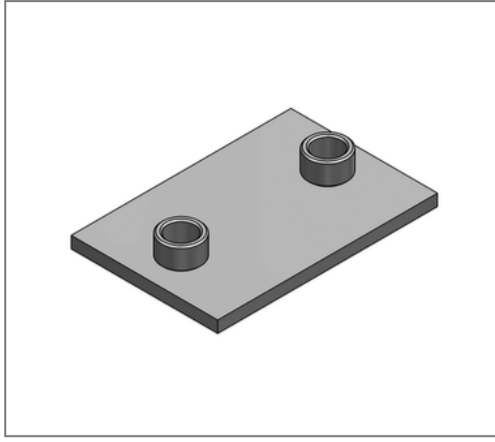

Commercial details

Part no.	0771811
EAN/GTIN	4250928418364
Packing unit	1 pcs
Quantity unit	pcs
Weight	4,95 kg/pc
Product group	04-077
Price unit	100

QR code

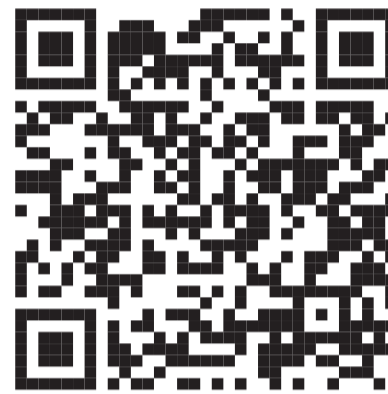

Technical data

Material	Steel
Material type	S235
Surface	galvanized

Product details

Connection	1"
Length L	300 mm
Width B	200 mm
Thickness S	10 mm
load F_z	5,6 kN
Axial dimension a	25 mm
Number of connections	2
max. sliding distance axial hanging	160 mm
max. sliding distance axial standing	250 mm

Remark

Note	delivery time on demand
------	-------------------------