

## ■ Slider axial GL 37 Connection 1 x M8

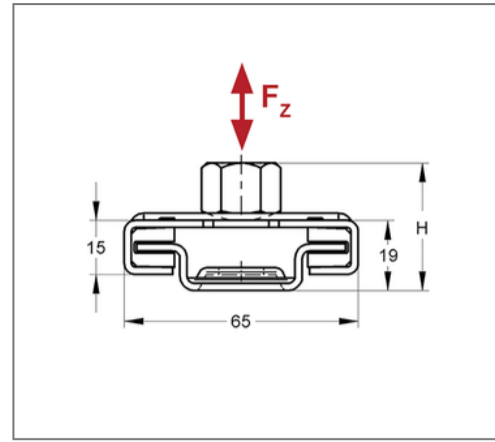
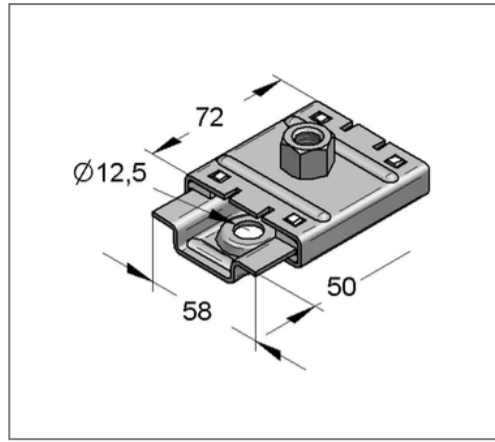
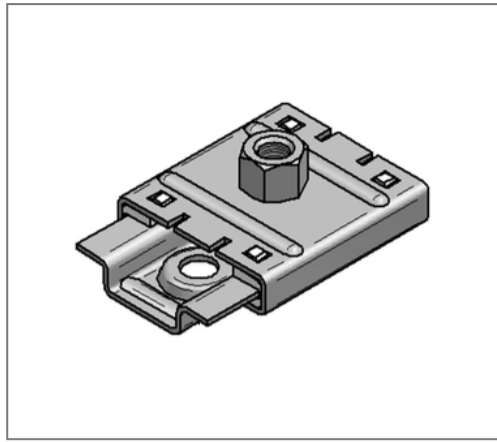

### Commercial details

Part no.	0770515
EAN/GTIN	4250928417848
Packing unit	25 pcs
Quantity unit	pcs
Weight	0,204 kg/pc
Product group	04-174
Price unit	1

### QR code



### Specification

Application absorption of axial length expansion for standing, area hanging, horizontal or vertical passed pipes

### Technical data

Surface	galvanized
Material sliding element	Steel
Material type sliding element	S235
Material sliding stripe	Plastic
Material name sliding stripe	Polyamide 6
min. temperature resistance	-30 °C
max. temperature resistance	110 °C

### Product details

Width	65 mm
Length	72 mm
Construction height H	32 mm
Connection	1 x M8
Static friction factor	0,2 - 0,3
max. sliding distance axial	37 mm
load $F_z$	1,3 kN
Hole-Ø	12,5 mm