

■ Slider axial GL 37 Connection 1 x M12

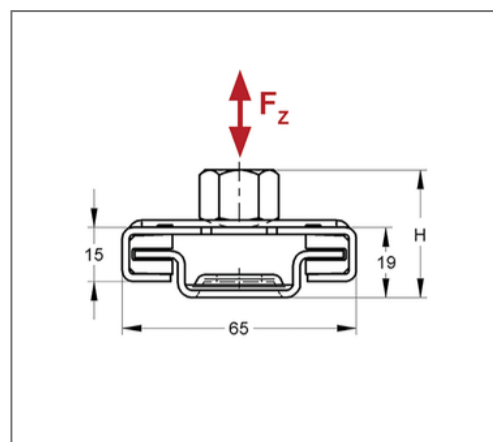
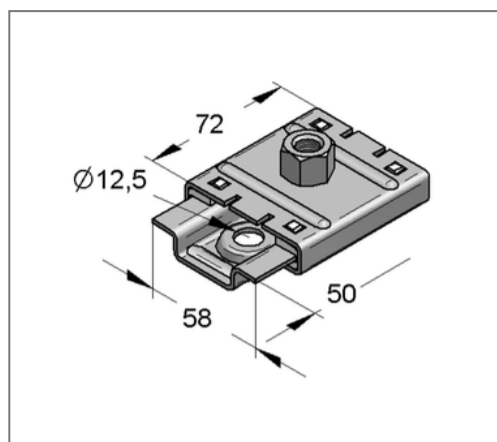
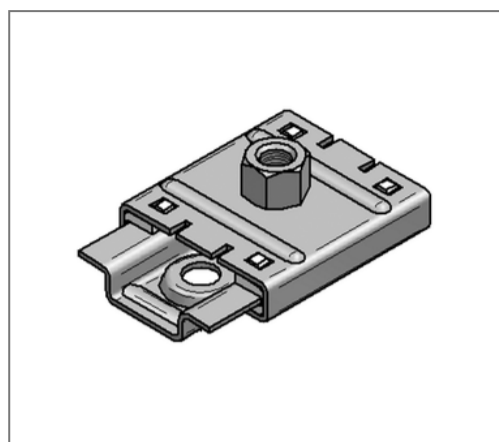

Commercial details

Part no.	0770531
EAN/GTIN	4250928417916
Packing unit	25 pcs
Quantity unit	pcs
Weight	0,223 kg/pc
Product group	04-174
Price unit	1

QR code



Specification

Application absorption of axial length expansion for standing, area hanging, horizontal or vertical passed pipes

Technical data

Surface	galvanized
Material sliding element	Steel
Material type sliding element	S235
Material sliding stripe	Plastic
Material name sliding stripe	Polyamide 6
min. temperature resistance	-30 °C
max. temperature resistance	110 °C

Product details

Width	65 mm
Length	72 mm
Construction height H	36 mm
Connection	1 x M12
Static friction factor	0,2 - 0,3
max. sliding distance axial	37 mm
load F_z	1,3 kN
Hole-Ø	12,5 mm