

## ■ Slider axial GL 100 Connection 2 x M12 with lug

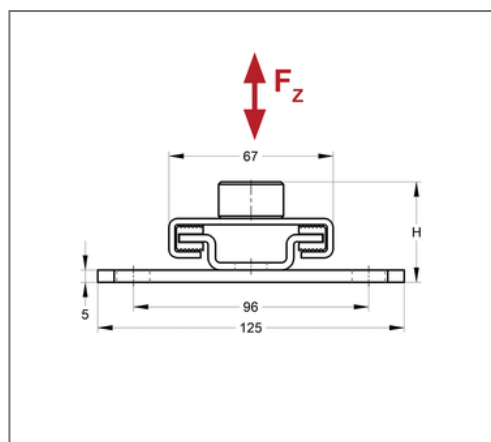
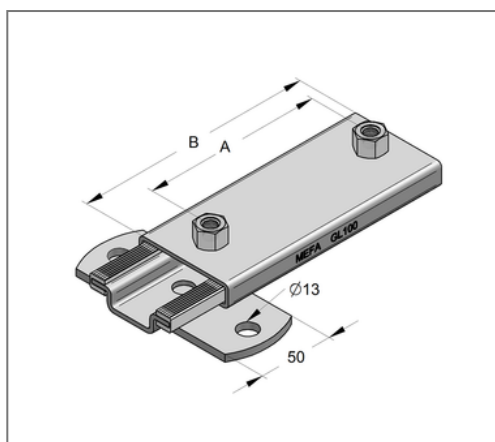
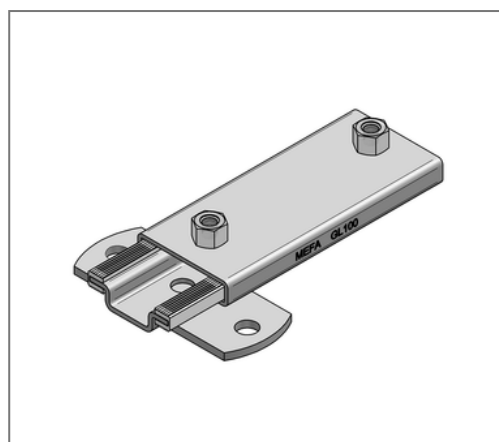

### Commercial details

Part no.	0770538
EAN/GTIN	4250928417961
Packing unit	20 pcs
Quantity unit	pcs
Weight	0,793 kg/pc
Product group	04-174
Price unit	1

### QR code



### Specification

Application area	absorption of axial length expansion for standing, hanging, horizontal or vertical passed pipes
Specification	with lug

### Technical data

Surface	galvanized
Material sliding element	Steel
Material type sliding element	S235
Material sliding stripe	Plastic
Material name sliding stripe	Polyamide 6
min. temperature resistance	-30 °C
max. temperature resistance	110 °C

### Product details

Width	125 mm
Length	160 mm
Construction height	42 mm
Connection	2 x M12
Number of connections	2
Thread	M12
Static friction factor	0,2 - 0,3
max. sliding distance axial	68 mm
load $F_Z$	3 kN
Hole-Ø	13 mm