

■ Trapeze hanger MU-S M8

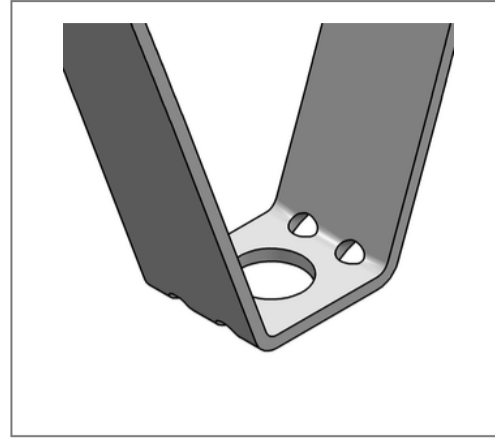
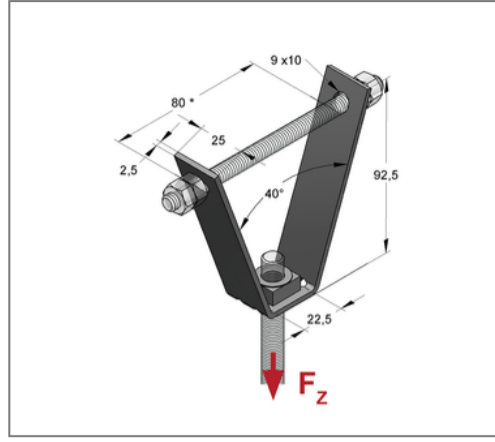
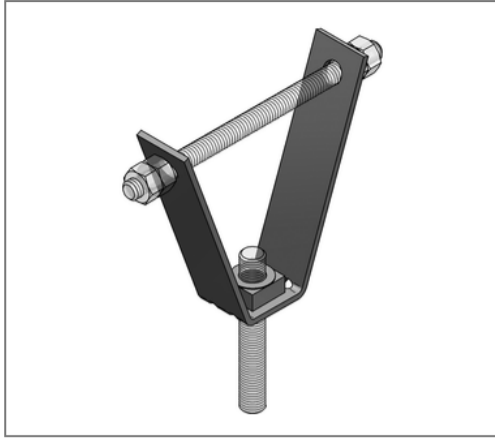

Commercial details

Part no.	0783900
EAN/GTIN	4250928418845
Packing unit	100 pcs
Quantity unit	pcs
Weight	0,111 kg/pc
Product group	05-078
Price unit	100

QR code



Certification



Specification

Application area	For mounting the pipelines, ventilation ducts and profile rails directly under a trapeze sheeting.
Specification	welded nut

Technical data

Material	Steel
Material type	S235/DD11
Surface	galvanized

Product details

Height	92,5 mm
load Fz	2 kN
Material thickness	2,5 mm
Width material	25 mm
Hole-Ø	9,5 mm
Connection thread	M8
Width absorption inside	22,5 mm