

■ Threaded rod DIN 976-1 M10 x 3,000 mm galv. FK 4.6

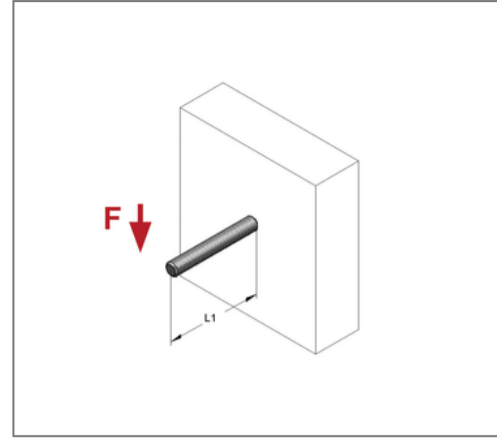
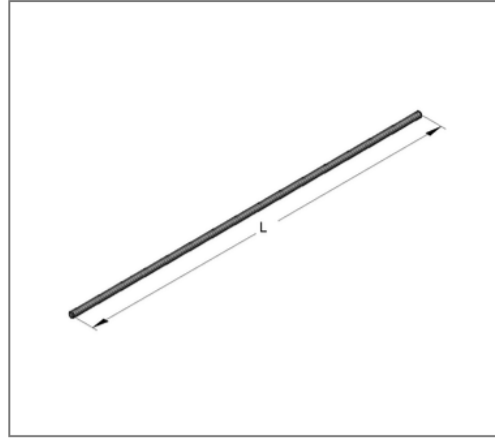
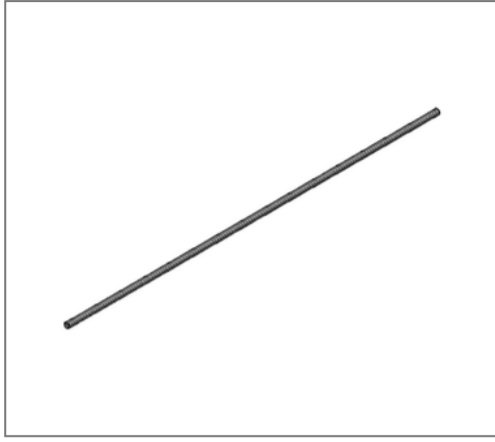

Commercial details

Part no.	0730505
EAN/GTIN	4250928416544
Packing unit	25 pcs
Bundle	25 pcs
Quantity unit	pcs
Weight	1,53 kg/pc
Product group	05-073
Price unit	1

QR code

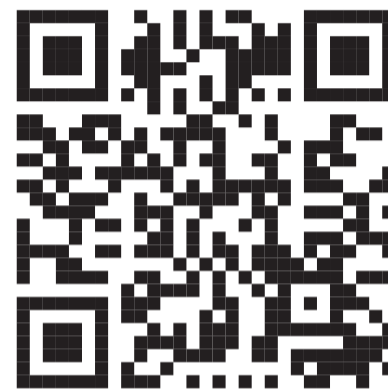

Technical data

Material	Steel
Surface	galvanized
Strength class	4.6

Product details

Thread	M10
Length	3000 mm
load at fire resistance period 30 min.	1,27 kN
load at fire resistance period 60 min.	0,72 kN
load at fire resistance period 90 min.	0,55 kN
tension load	14,2 kN