

■ Threaded rod DIN 976-1 M16 x 2,000 mm galv. FK 4.6

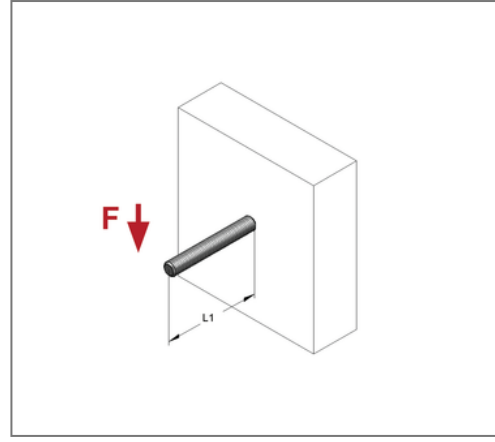
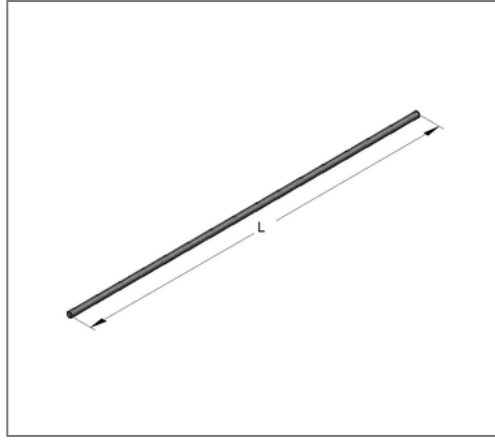
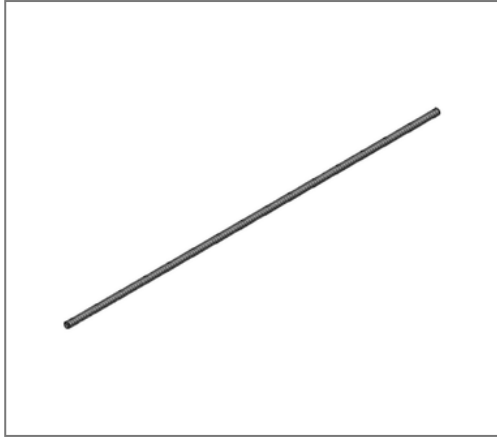

Commercial details

Part no.	0730378
EAN/GTIN	4250928416520
Packing unit	10 pcs
Bundle	10 pcs
Quantity unit	pcs
Weight	2,61 kg/pc
Product group	05-073
Price unit	1

QR code



Technical data

Material	Steel
Surface	galvanized
Strength class	4.6

Product details

Thread	M16
Length	2000 mm
load at fire resistance period 30 min.	3,42 kN
load at fire resistance period 60 min.	1,96 kN
load at fire resistance period 90 min.	1,49 kN
tension load	38,43 kN

Remark

Notice	DIN 976-1
--------	-----------