

■ Hexagon screw EN ISO 4017 M8 x 25 mm galv. FK 8.8

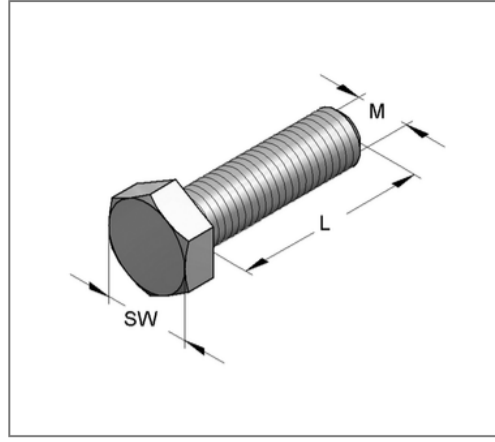
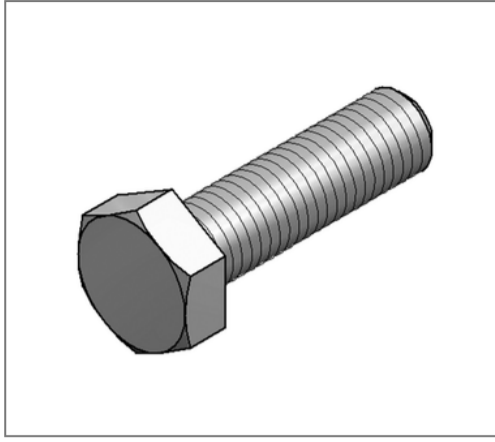

Commercial details

Part no.	3204255
EAN/GTIN	4250928437945
Packing unit	100 pcs
Quantity unit	pcs
Weight	0,0157 kg/pc
Product group	05-320
Price unit	100

QR code

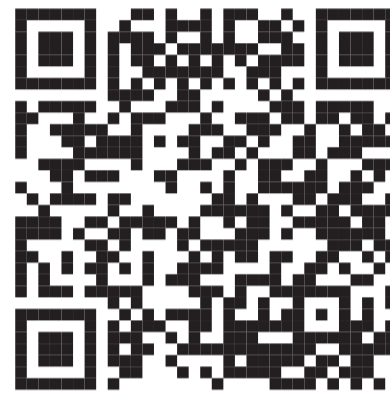

Technical data

Material	Steel
Surface	galvanized
Strength class	8.8

Product details

Thread M	M8
Length L	25 mm
Wrench size SW	13
Shape head	Hexagon head

Remark

Notice	DIN EN ISO 4017
--------	-----------------