

■ Hexagon screw EN ISO 4017 M12 x 45 mm galv. FK 8.8

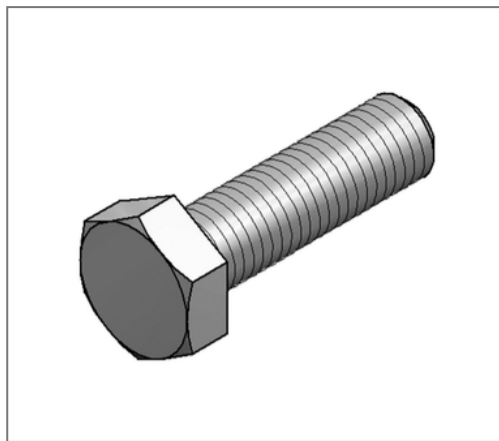

Commercial details

Part no.	32066064
EAN/GTIN	4250928438140
Packing unit	100 pcs
Quantity unit	pcs
Weight	0,0558 kg/pc
Product group	05-320
Price unit	100

QR code



Technical data

Material	Steel
Surface	galvanized
Strength class	8.8

Product details

Thread M	M12
Length L	45 mm
Wrench size SW	19
Shape head	Hexagon head

Remark

Notice	DIN EN ISO 4017
--------	-----------------