

■ Beam clamp Cast iron F3 Clamping range 1 - 30 mm Hole for M10

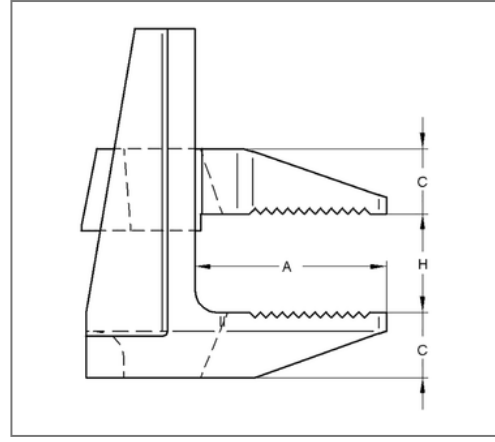
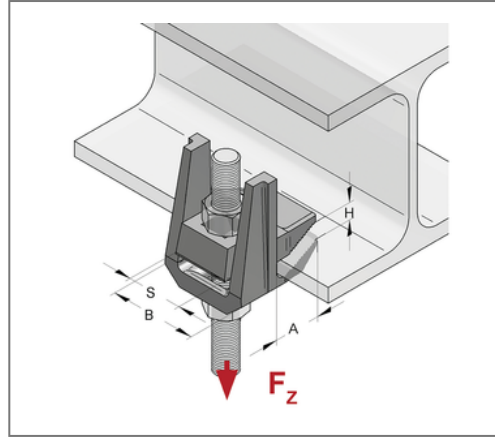
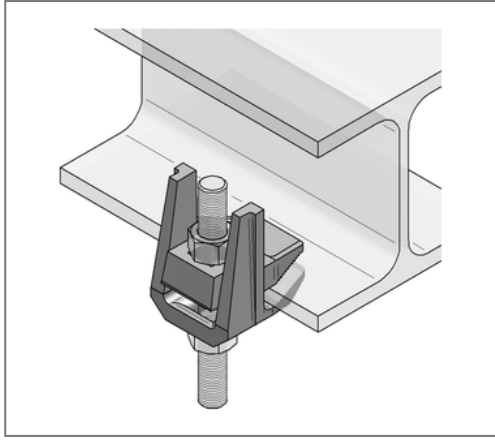

Commercial details

Part no.	0579625
EAN/GTIN	4250928414755
Packing unit	1 pcs
Quantity unit	pcs
Weight	0,190 kg/pc
Product group	05-057
Price unit	1

QR code



Certification



Specification

Brand	Lindapter
Application area	mounting of suspensions on steel girder
Type of attachment	with pass hole

Technical data

Material	Malleable cast iron
Surface	hot-dip galvanized
min. clamping thickness H	1 mm
max. clamping thickness H	30 mm

Product details

load Fz	1,2 kN
Thread	for M10
Thickness C	10 mm
Tightening torque	20 Nm