

■ Beam clamp Cast iron F3 Clamping range 1 - 55 mm Hole for M16

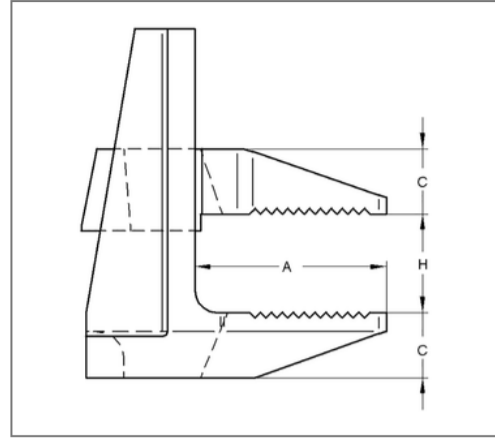
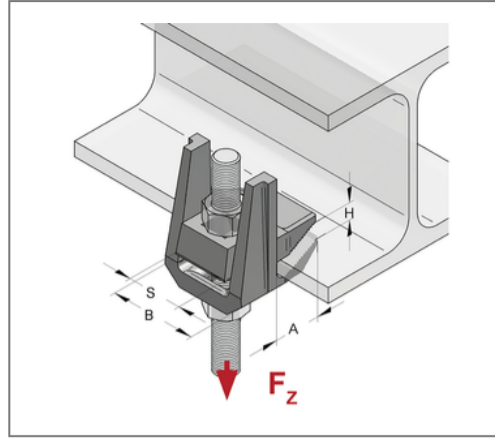
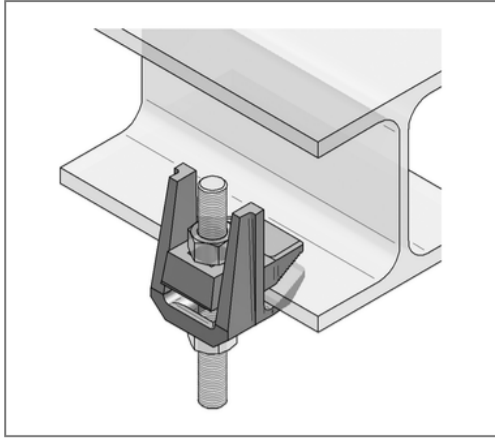

Commercial details

Part no.	0579649
EAN/GTIN	4250928414779
Packing unit	1 pcs
Quantity unit	pcs
Weight	0,810 kg/pc
Product group	05-057
Price unit	1

QR code



Certification



Specification

Brand	Lindapter
Application area	mounting of suspensions on steel girder
Type of attachment	with pass hole

Technical data

Material	Malleable cast iron
Surface	hot-dip galvanized
min. clamping thickness H	1 mm
max. clamping thickness H	55 mm

Product details

load F_z	4 kN
Thread	for M16
Thickness C	16 mm
Tightening torque	93 Nm