

■ Insulated pipe clamp Polar Plus 48,3 mm Insulation 20 M8/M10

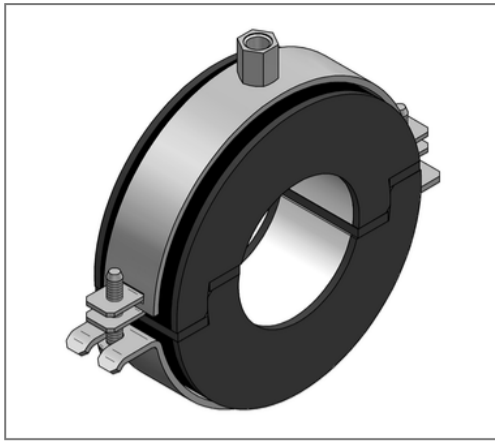

Commercial details

Part no.	74620480
EAN/GTIN	4250928442567
Packing unit	20 pcs
Quantity unit	pcs
Weight	0,164 kg/pc
Product group	06-746
Price unit	1

QR code



Certification



Specification

Application area	A thermal decoupled mounting of tubes guarantees a reliable prevention of condensate for refrigeration, air-conditioning and drinking water technologies in the sector pipe-clamping
Insulation body	AC/PU

Product details

Connection	M8/M10
Connection height A	39 mm
Width B	124 mm
Insulation thickness	20 mm
load Fz	0,46 kN
Length shell L	36 mm
statical load shell	0,38 N/mm ²

Technical data

Material	Steel
Material type	DD11
Surface	galvanized
Class	B2
min. temperature resistance	-50 °C
max. temperature resistance	105 °C
Thermal conductivity	0,031 W/mK
Density shell	145 kg/m ³

Remark

Notice	Von Umtausch und Rücknahme ausgeschlossen. Sonderanfertigungen auf Anfrage.
--------	--