

■ Insulated pipe clamp Husky IV 19 63,5 mm Insulation 22,5 M8/M10

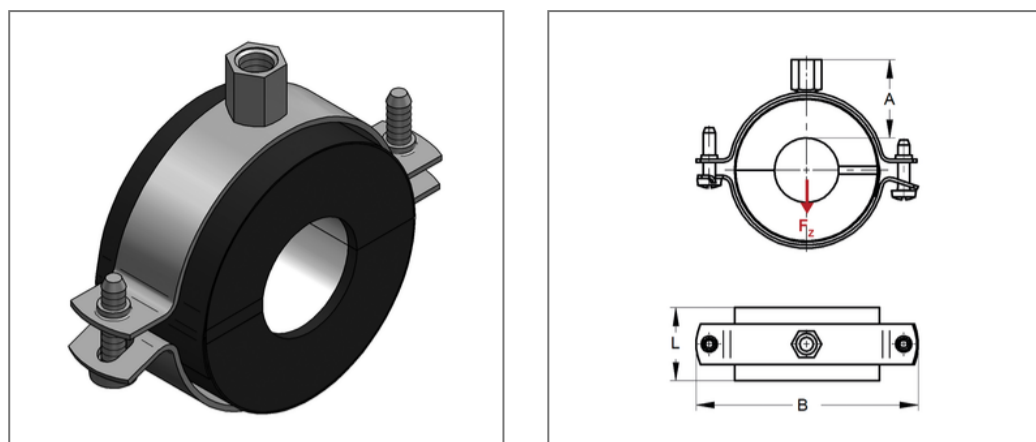

Commercial details

Part no.	6840641
EAN/GTIN	4250928440822
Packing unit	8 pcs
Quantity unit	pcs
Weight	0,275 kg/pc
Product group	06-684
Price unit	1

QR code



Certification



Specification

Application area	A thermal decoupled mounting of tubes guarantees a reliable prevention of condensate for refrigeration, air-conditioning and drinking water technologies in the sector pipe-clamping
Insulation body	KA/PU

Technical data

Material	Steel
Material type	DD11
Material coat	Plastic
Surface	galvanized
Class	B2
min. temperature resistance	-45 °C
max. temperature resistance	105 °C
Thermal conductivity	0,029 W/mK
Density shell	120 kg/m ³
Water vapour diffusion resistance	20000 μ

Product details

Connection	M8/M10
Connection height A	44 mm
Width B	153 mm
Insulation thickness	22,5 mm
load F _Z	0,54 kN
Length shell L	42 mm
statical load shell	0,27 N/mm ²

Remark

Notice	Von Umtausch und Rücknahme ausgeschlossen. Sonderanfertigungen auf Anfrage.
--------	--