

## ■ Insulated pipe clamp RG80s ALU/PU 21,3 mm Insulation 40 x 40 mm M8/M10

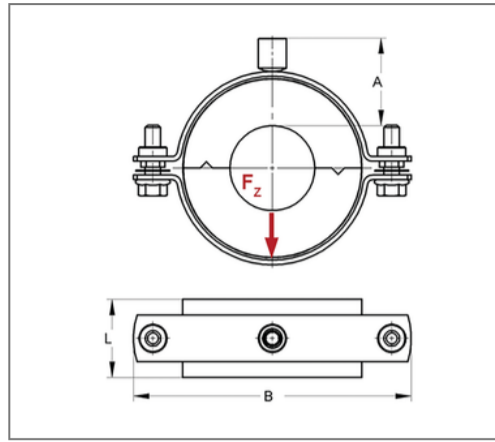
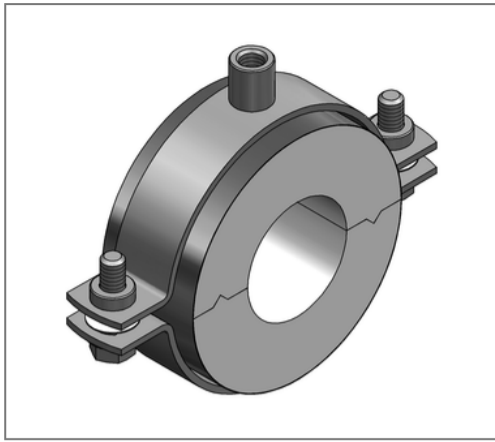

### Commercial details

Part no.	71402249
EAN/GTIN	4250928441690
Packing unit	1 pcs
Quantity unit	pcs
Weight	0,252 kg/pc
Product group	06-714
Price unit	1

### QR code



### Certification



### Specification

Application area	A thermal decoupled mounting of tubes guarantees a reliable prevention of condensate for refrigeration, air-conditioning and drinking water technologies in the sector pipe-clamping
Insulation body	ALU/PU

### Technical data

Material	Steel
Material type	DD11
Material coat	Aluminum foil
Surface	galvanized
Class	B2
min. temperature resistance	-50 °C
max. temperature resistance	120 °C
Thermal conductivity	0,025 W/mK
Density shell	80 kg/m <sup>3</sup>
Density coat	2700 kg/m <sup>3</sup>
Thicknes coat	0,08 mm
Water vapour diffusion resistance	18750 μ

### Product details

Connection	M8/M10
Connection height A	62 mm
Width B	143 mm
Insulation thickness	40 mm
load F <sub>z</sub>	0,1 kN
Length shell L	40 mm
statical load shell	0,1 N/mm <sup>2</sup>

### Remark

Delivery time	5 working days, ex works
Notice	Von Umtausch und Rücknahme ausgeschlossen.