

■ Insulated pipe clamp RG80s ALU/PU 33,7 mm Insulation 40 x 40 mm M8/M10

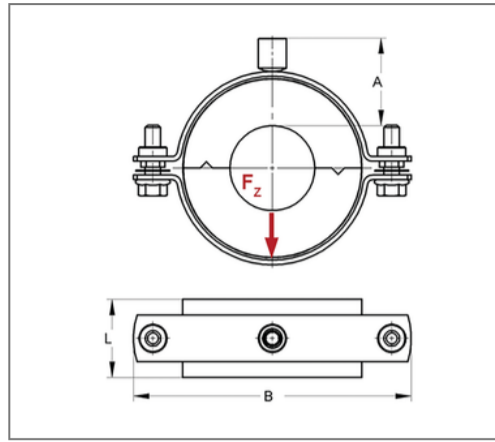
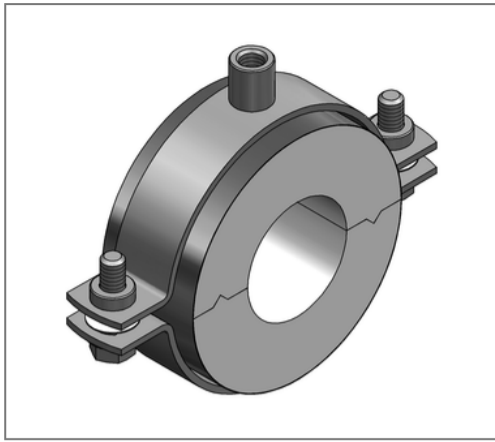

Commercial details

Part no.	71403449
EAN/GTIN	4250928441713
Packing unit	1 pcs
Quantity unit	pcs
Weight	0,262 kg/pc
Product group	06-714
Price unit	1

QR code



Certification



Specification

Application area	A thermal decoupled mounting of tubes guarantees a reliable prevention of condensate for refrigeration, air-conditioning and drinking water technologies in the sector pipe-clamping
Insulation body	ALU/PU

Technical data

Material	Steel
Material type	DD11
Material coat	Aluminum foil
Surface	galvanized
Class	B2
min. temperature resistance	-50 °C
max. temperature resistance	120 °C
Thermal conductivity	0,025 W/mK
Density shell	80 kg/m ³
Density coat	2700 kg/m ³
Thicknes coat	0,08 mm
Water vapour diffusion resistance	18750 μ

Product details

Connection	M8/M10
Connection height A	60 mm
Width B	152 mm
Insulation thickness	40 mm
load F _z	0,2 kN
Length shell L	40 mm
statical load shell	0,1 N/mm ²

Remark

Delivery time	5 working days, ex works
Notice	Von Umtausch und Rücknahme ausgeschlossen.