

## ■ Bolt anchor BZ plus M8 Length thread 32 mm Steel

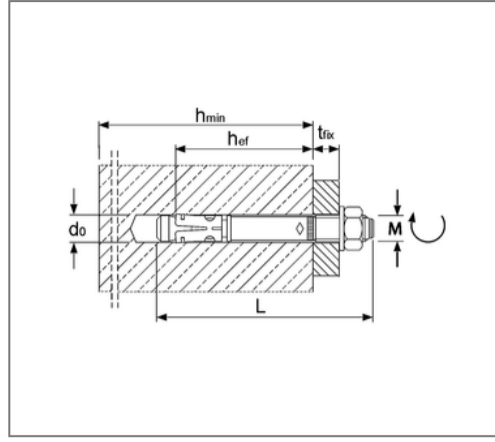

### Commercial details

Part no.	221108010
EAN/GTIN	4043315045379
Packing unit	100 pcs
Quantity unit	pcs
Weight	0,0299 kg/pc
Product group	07-221
Price unit	100

### QR code



### Certification

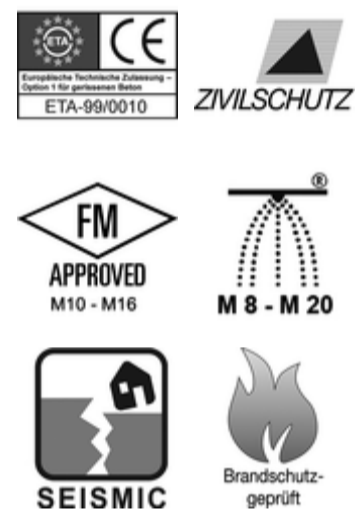

### Specification

Brand	MKT
Application	For cracked and non-cracked concrete C20/25 to C50/60.

### Technical data

Material	Steel
Surface	galvanized

### Product details

Clamping thickness	10 mm
max. clamping thickness red.	21 mm
Drill diameter	8 mm
Drilling hole depth	60 mm
Drilling hole depth red.	49 mm
Setting depth	52 mm
Depth of anchoring	46 mm
Depth of anchoring red.	35 mm
Length dowel	75 mm
Thread	M8

### Remark

Delivery time	V4A - 3 working days, ex works
---------------	--------------------------------