

■ Bolt anchor BZ plus M10 Length thread 62 mm Steel

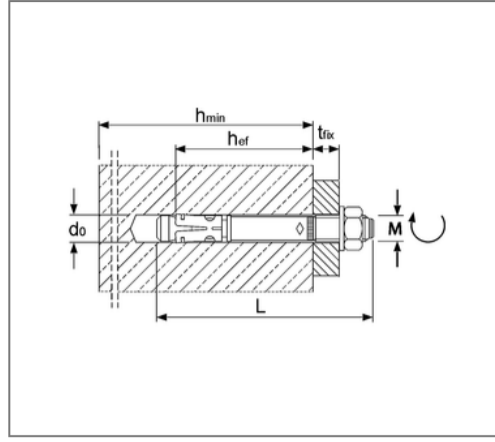

Commercial details

Part no.	221110030
EAN/GTIN	4043315045461
Packing unit	50 pcs
Quantity unit	pcs
Weight	0,0688 kg/pc
Product group	07-221
Price unit	100

QR code



Certification



Specification

Brand	MKT
Application	For cracked and non-cracked concrete C20/25 to area C50/60.

Technical data

Material	Steel
Surface	galvanized

Product details

Clamping thickness	30 mm
max. clamping thickness red.	50 mm
Drill diameter	10 mm
Drilling hole depth	75 mm
Drilling hole depth red.	55 mm
Setting depth	68 mm
Depth of anchoring	60 mm
Depth of anchoring red.	40 mm
Length dowel	110 mm
Thread	M10

Remark

Delivery time	V4A - 3 working days, ex works
---------------	--------------------------------