

■ Bolt anchor BZ plus M12 Length thread 86 mm Steel

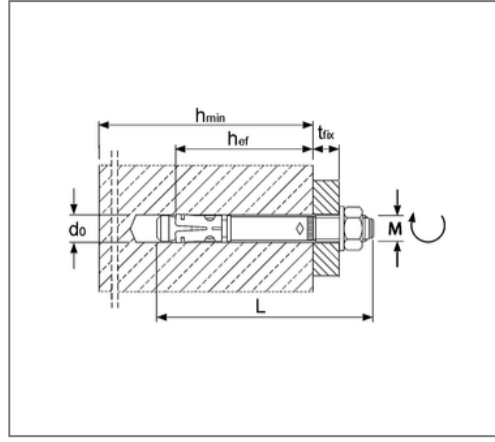

Commercial details

Part no.	221112050
EAN/GTIN	4043315096869
Packing unit	25 pcs
Quantity unit	pcs
Weight	0,129 kg/pc
Product group	07-221
Price unit	100

QR code



Certification



Specification

Brand	MKT
Application	For cracked and non-cracked concrete C20/25 to area C50/60.

Technical data

Material	Steel
Surface	galvanized

Product details

Clamping thickness	50 mm
max. clamping thickness red.	70 mm
Drill diameter	12 mm
Drilling hole depth	90 mm
Drilling hole depth red.	70 mm
Setting depth	80 mm
Depth of anchoring	70 mm
Depth of anchoring red.	50 mm
Length dowel	145 mm
Thread	M12

Remark

Delivery time	V4A - 3 working days, ex works
---------------	--------------------------------