

■ Bolt anchor BZ plus M16 Length thread 56 mm Steel

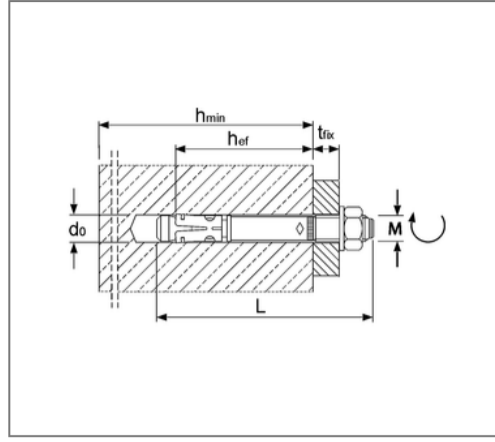

Commercial details

Part no.	221116015
EAN/GTIN	4043315045119
Packing unit	20 pcs
Quantity unit	pcs
Weight	0,216 kg/pc
Product group	07-221
Price unit	100

QR code



Certification



Specification

Brand	MKT
Application	For cracked and non-cracked concrete C20/25 to C50/60.

Technical data

Material	Steel
Surface	galvanized

Product details

Clamping thickness	15 mm
max. clamping thickness red.	35 mm
Drill diameter	16 mm
Drilling hole depth	110 mm
Drilling hole depth red.	90 mm
Setting depth	97 mm
Depth of anchoring	85 mm
Depth of anchoring red.	65 mm
Length dowel	135 mm
Thread	M16

Remark

Delivery time	V4A - 3 working days, ex works
---------------	--------------------------------