

■ Ventilation pipe clamp Doppio 20x1,5 DN 71 M8/M10 TPE

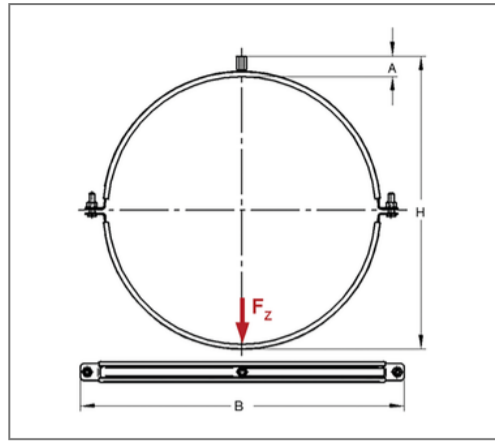

Commercial details

Part no.	0449071
EAN/GTIN	4250928410900
Packing unit	50 pcs
Quantity unit	pcs
Weight	0,128 kg/pc
Product group	08-044
Price unit	100

QR code



Certification



Specification

Application area	Pipe clamp for fixing pipes.
Specification	two-part
Connection	M8/M10
Closure	with snap-in closure

Technical data

Material	Steel
Material type	S235
Surface	galvanized
Insulation thickness	4,5 mm
Temperature resistance	-35 °C - 100 °C
Sound insulation lining	TPE

Product details

Connection height A	24 mm
Width B	107 mm
Colour sound insulation lining	black
Höhe H	104 mm
Material dimension	20x1,5 mm
load Fz	0,61 kN
Outer pipe diameter	75 mm
Closure screw	M6