

■ Ventilation pipe clamp Doppio 20x1,5 DN 90 M8/M10 TPE

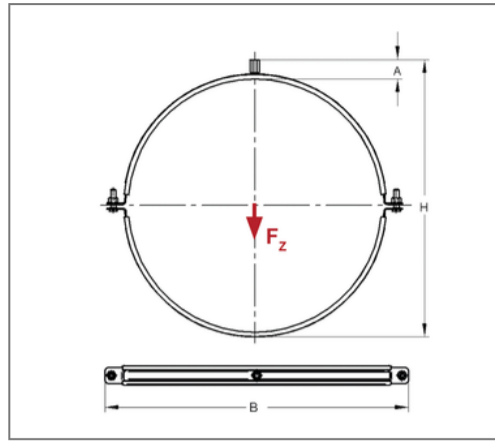

Commercial details

Part no.	0449090
EAN/GTIN	4250928410924
Packing unit	50 pcs
Quantity unit	pcs
Weight	0,149 kg/pc
Product group	08-044
Price unit	100

QR code



Certification



Specification

Application area	Pipe clamp for fixing pipes.
Specification	two-part
Connection	M8/M10
Closure	Snap-in closure

Technical data

Material	Steel
Material type	S235
Surface	galvanized
Insulation thickness	4,5 mm
Temperature resistance	-35 °C - 100 °C
Sound insulation lining	TPE

Product details

Connection height A	24 mm
Width B	126 mm
Colour sound insulation lining	black
Höhe H	123 mm
Material dimension	20x1,5 mm
load F_z	0,61 kN
Outer pipe diameter	94 mm
Closure screw	val.Verschlusschraube.M6