

## ■ Ventilation pipe clamp Doppio 20x1,5 DN 180 M8/M10 TPE

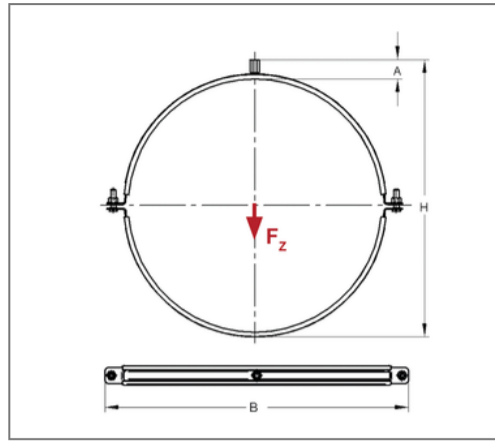

### Commercial details

Part no.	0449180
EAN/GTIN	4250928410993
Packing unit	25 pcs
Quantity unit	pcs
Weight	0,247 kg/pc
Product group	08-044
Price unit	100

### QR code



### Certification



### Specification

Application area	Pipe clamp for fixing pipes.
Specification	two-part
Connection	M8/M10
Closure	Snap-in closure

### Technical data

Material	Steel
Material type	S235
Surface	galvanized
Insulation thickness	4,5 mm
Temperature resistance	-35 °C - 100 °C
Sound insulation lining	TPE

### Product details

Connection height A	24 mm
Width B	216 mm
Colour sound insulation lining	black
Höhe H	214 mm
Material dimension	20x1,5 mm
load $F_z$	0,61 kN
Outer pipe diameter	185 mm
Closure screw	M6