

■ Ventilation pipe clamp Doppio 25x1,5 DN 280 M8/M10 TPE

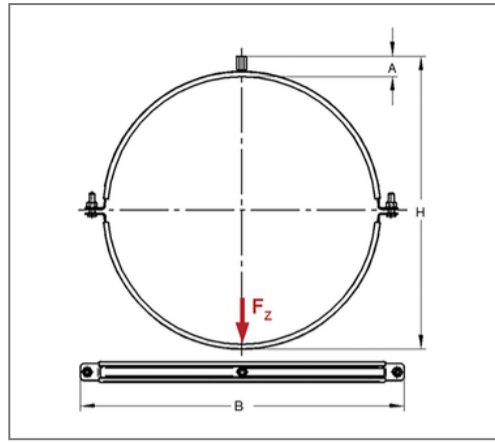

Commercial details

Part no.	0449280
EAN/GTIN	4250928411037
Packing unit	10 pcs
Quantity unit	pcs
Weight	0,466 kg/pc
Product group	08-044
Price unit	100

QR code



Certification



Specification

Application area	Pipe clamp for fixing pipes.
Specification	two-part
Connection	M8/M10
Closure	without snap-in closure

Technical data

Material	Steel
Material type	S235
Surface	galvanized
Insulation thickness	4,5 mm
Temperature resistance	-35 °C - 100 °C
Sound insulation lining	TPE

Product details

Connection height A	24 mm
Width B	328 mm
Colour sound insulation lining	black
Höhe H	314 mm
Material dimension	25x1,5 mm
load Fz	1,32 kN
Outer pipe diameter	285 mm
Closure screw	M8