

■ Ventilation pipe clamp Doppio 25x2,5 DN 500 M8/M10 TPE

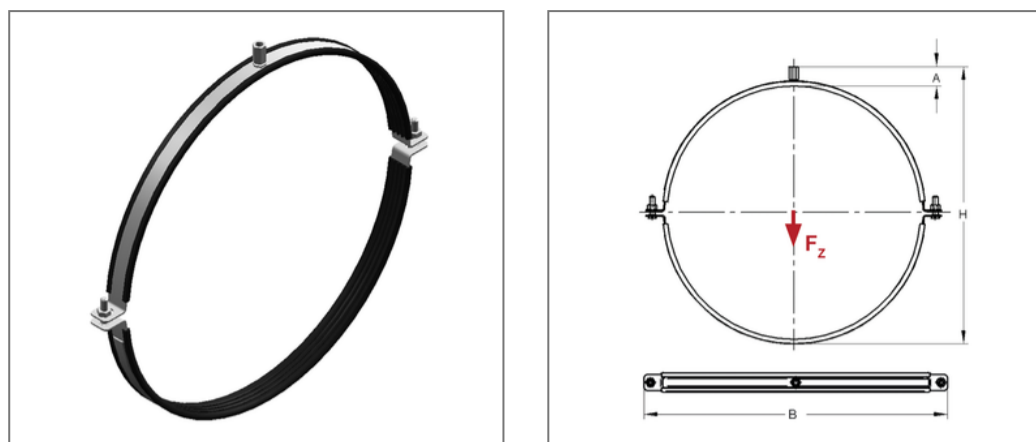

Commercial details

Part no.	0449500
EAN/GTIN	4250928411099
Packing unit	1 pcs
Quantity unit	pcs
Weight	1,10 kg/pc
Product group	08-044
Price unit	100

QR code



Certification



Specification

Application area	Pipe clamp for fixing pipes.
Specification	two-part
Connection	M8/M10
Closure	Screw coupling

Technical data

Material	Steel
Material type	S235
Surface	galvanized
Insulation thickness	4,5 mm
Temperature resistance	-35 °C - 100 °C
Sound insulation lining	TPE

Product details

Connection height A	26 mm
Width B	578 mm
Colour sound insulation lining	black
Höhe H	538 mm
Material dimension	25x2,5 mm
load F_z	1,97 kN
Outer pipe diameter	507 mm
Closure screw	M8