

## ■ Duct holder LLN Height 255 mm Rubber riveted

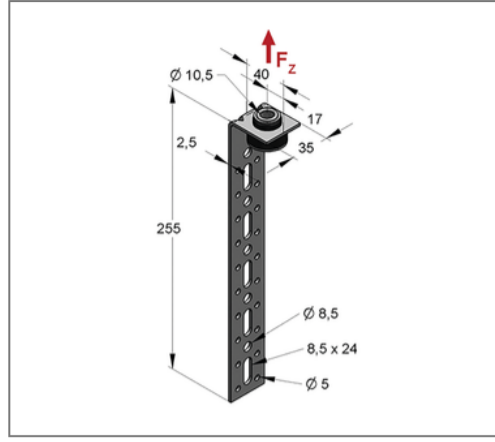

### Commercial details

Part no.	9998372
EAN/GTIN	4250928446978
Packing unit	50 pcs
Quantity unit	pcs
Weight	0,190 kg/pc
Product group	08-981
Price unit	100

### QR code



### Certification



### Specification

Application area	For mounting of air ducts
Specification	light

### Technical data

Material	Steel
Material type	S235
Surface	galvanized
min. temperature resistance	-35 °C
max. temperature resistance	100 °C
Sound insulation lining	Rubber SBR

### Product details

Connection	M8/M10
Height	255 mm
Length	40 mm
Material thickness	2,5 mm
Width material	35 mm
load Fz	0,9 kN