

■ Pipe clamp HDC 30x2,5 31 - 35 mm M8 unlined

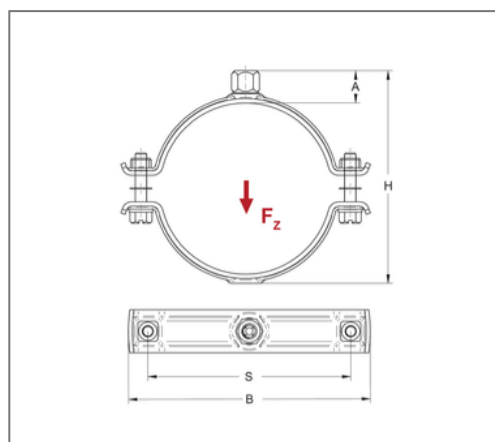

Commercial details

Part no.	47300031
EAN/GTIN	4250928458162
Packing unit	50 pcs
Quantity unit	pcs
Weight	0,155 kg/pc
Product group	12-034
Price unit	100

QR code



Certification



Specification

Brand	Jiangmen Eurofix
Application	Pipe clamp with connection thread according to area sprinkler guidelines for Sprinkler systems.
Specification	two-part
Connection	M8

Technical data

Material	Steel
Surface	galvanized
Sound insulation lining	unlined

Product details

Center distance S	55 mm
Connection height A	16 mm
Width B	77 mm
Höhe H	55 mm
Material dimension	30x2,5 mm
load F_z	2,5 kN
min. outside pipe diameter	31 mm
max. outer pipe diameter	35 mm
Outside pipe diameter inch	1 inch
Closure screw	M8