

■ Console C-profile 45/45 SP L= 630 mm Plate vertical galv.

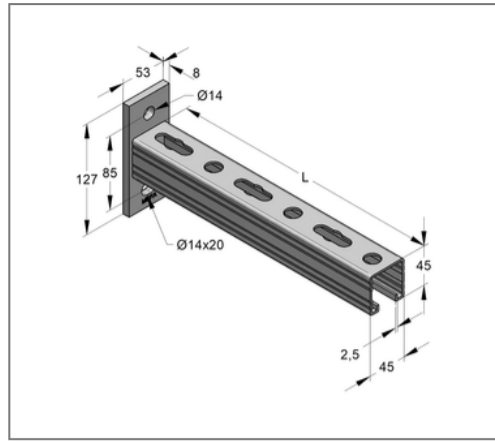
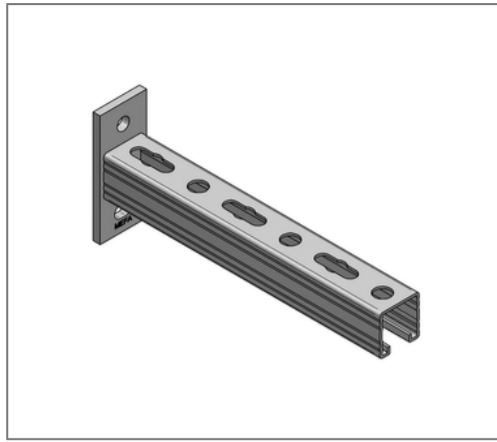

Commercial details

Part no.	9992309
EAN/GTIN	4250928448897
Packing unit	5 pcs
Quantity unit	pcs
Weight	2,23 kg/pc
Product group	02-083
Price unit	1

QR code



Specification

Application Console for the production of cantilever structures area for the support of suspended and standing pipe loads for sprinkler piping.

Technical data

Material	Steel
Surface	galvanized

Product details

Width plate	53 mm
Length plate	127 mm
Hole distance	85 mm
Plate thickness	8 mm
Width profile	45 mm
Profile height	45 mm
Length console L	630 mm
Elongated hole plate	14x20 mm
load F1	1,66 kN
load F2	0,83 kN
load q0	2,63 kN/m
Profile thickness	2,5 mm