

■ Pipe clamp Stainless steel V4A 20x1,5 21 - 25 mm M8 TPE

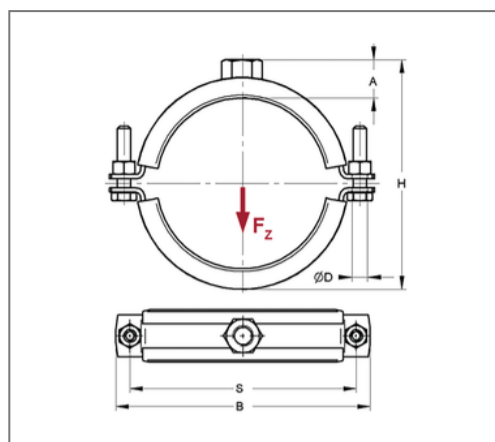
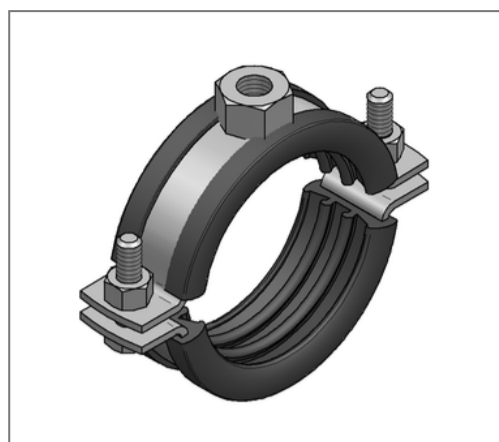

Commercial details

Part no.	0498175
EAN/GTIN	4250928413789
Packing unit	50 pcs
Quantity unit	pcs
Weight	0,0630 kg/pc
Product group	13-049
Price unit	100

QR code



Certification



Specification

Application area	Pipe clamp for fixing pipes.
Specification	two-part
Connection	M8
Closure	Screwed closure

Technical data

Material	Stainless steel
Material type	V4A
Insulation thickness	3,5 mm
Temperature resistance	-35 °C - 100 °C
Sound insulation lining	TPE

Product details

Center distance S	48 mm
Connection height A	11 mm
Width B	61 mm
Colour sound insulation lining	black
Höhe H	36 - 40 mm
Material dimension	20x1,5 mm
load Fz	0,75 kN
Clamping range	21 - 25 mm
Outside pipe diameter inch	1/2 inch
Closure screw	M6

Remark

Delivery time	2 working days, ex works
Notice	Other sizes and connection threads on demand.