

■ Console CENTUM XL 80 L= 960 mm hot-dip galv.

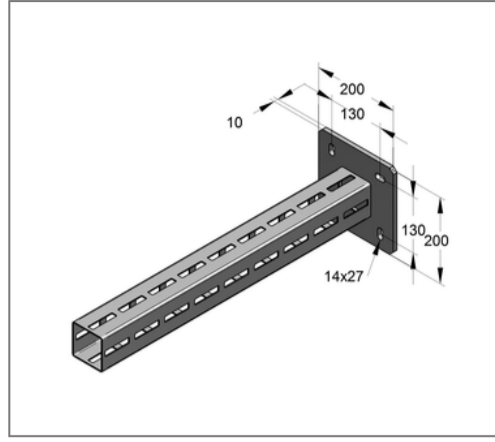
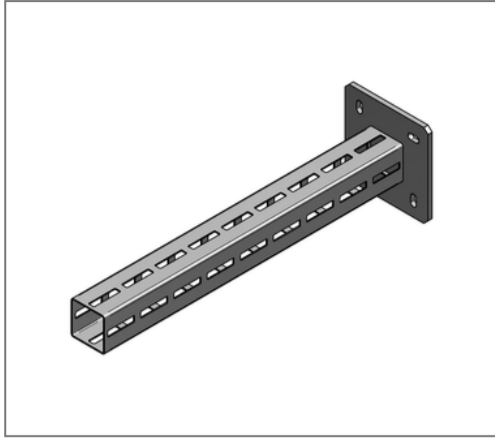

Commercial details

Part no.	1630800960
EAN/GTIN	4250928450388
Packing unit	1 pcs
Quantity unit	pcs
Weight	8,58 kg/pc
Product group	14-163
Price unit	1

QR code



Certification



Specification

Application area	Console for the production of cantilever structures for the support of suspended and standing pipe loads.
------------------	---

Technical data

Material	Steel
Surface	hot-dip galvanized

Product details

Width plate	200 mm
Length plate	200 mm
Hole distance	130 mm
Plate thickness	10 mm
Width profile	80 mm
Profile height	80 mm
Length console L	960 mm
Elongated hole plate	27x14 mm
load F1	6,29 kN
load F2	2,94 kN
load q0	6,55 kN/m
Profile thickness	2,5 mm