

■ Pipe clamp Form A TGA 60x8 356 mm without connection TPE galv.

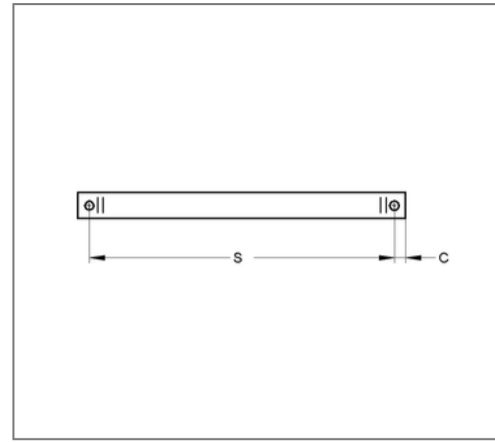
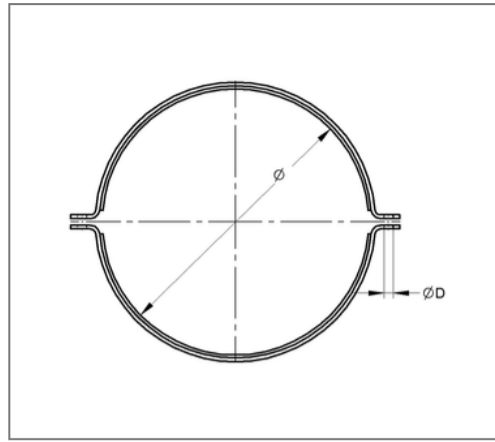

Commercial details

Part no.	109ggba0356
EAN/GTIN	4250928423764
Packing unit	1 pcs
Quantity unit	pcs
Weight	6,18 kg/pc
Product group	14-109
Price unit	1

QR code



Certification



Specification

Application area	pipe clamp for fixing pipes.
Specification	two-part
Connection	without connection

Technical data

Material	Steel
Material type	S235
Surface	galvanized
Insulation thickness	8 mm
Temperature resistance	-30 °C - 100 °C
Sound insulation lining	TPE

Product details

Center distance S	446 mm
Colour sound insulation lining	black
Material dimension	60x8 mm
load F_Z	11,5 kN
Outer pipe diameter	356 mm
Closure screw	M16