

■ Console C-profile 45/45 L= 420 mm Plate vertical hot-dip galv.

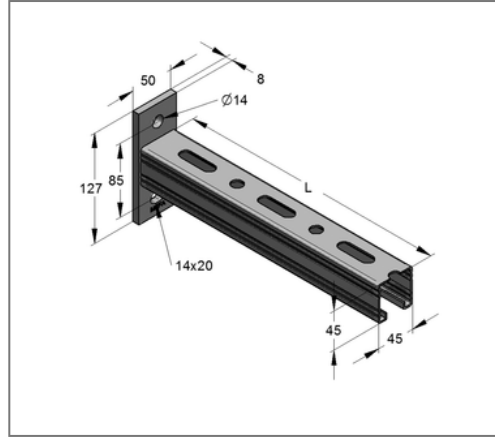
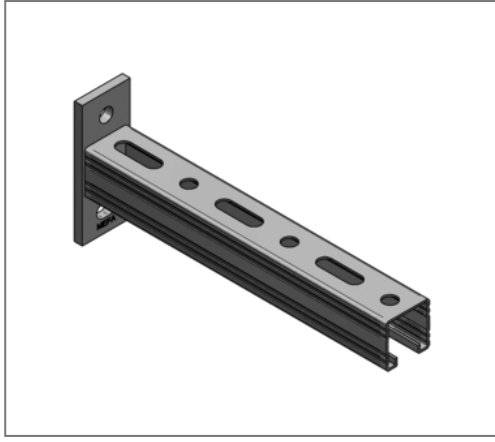

Commercial details

Part no.	180450420/fvz
EAN/GTIN	4250928456366
Packing unit	10 pcs
Quantity unit	pcs
Weight	1,52 kg/pc
Product group	02-083
Price unit	1

QR code

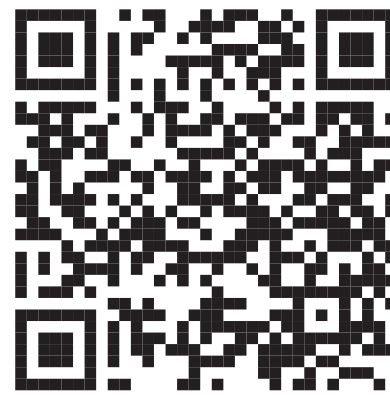

Certification



Specification

Application area	Console for the production of cantilever structures for the support of suspended and standing pipe loads.
------------------	---

Technical data

Material	Steel
Surface	hot-dip galvanized

Product details

Width plate	50 mm
Length plate	127 mm
Hole distance	85 mm
Plate thickness	8 mm
Width profile	45 mm
Profile height	45 mm
Length console L	420 mm
Elongated hole plate	14x20 mm
load F1	2,49 kN
load F2	1,24 kN
load q0	5,92 kN/m
Profile thickness	2 mm