

■ Roller bearing double radial-axial 508 - 965 mm 100 kN 100 mm hot-dip galv.

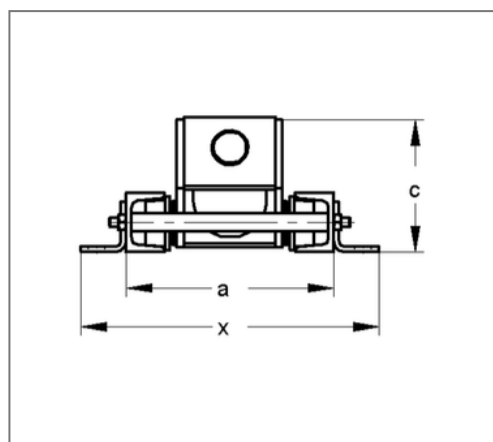
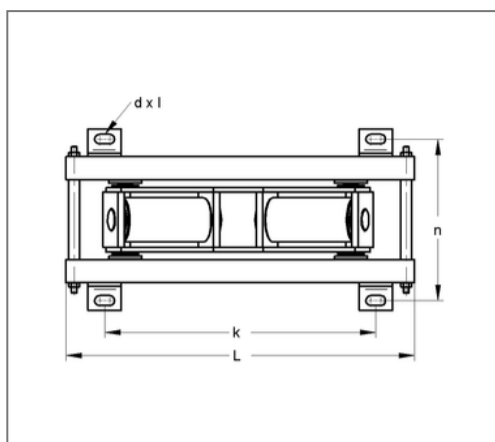
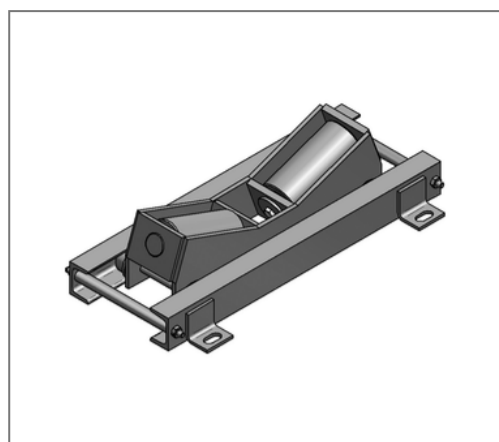

Commercial details

Part no.	150xfa100965
EAN/GTIN	4250928435538
Packing unit	1 pcs
Quantity unit	pcs
Weight	39,14 kg/pc
Product group	14-150
Price unit	1

QR code



Specification

Application roller bearing in double design for supporting area heavy pipelines on insulation-saddle.

Technical data

Material	Steel
Material type	S235
Surface	hot-dip galvanized

Product details

Height	145 mm
load F_z	100 kN
Length	630 mm
Elongated hole	18x36 mm
Material thickness	6 mm
Hole distance lengthwise	490 mm
Hole distance crosswise	296 mm
Width without lugs	232 mm
min. diameter roller support	508 mm
max. diameter roller support	965 mm