

## ■ Console C-profile 45/26 S L= 525 mm Plate vertical galv.

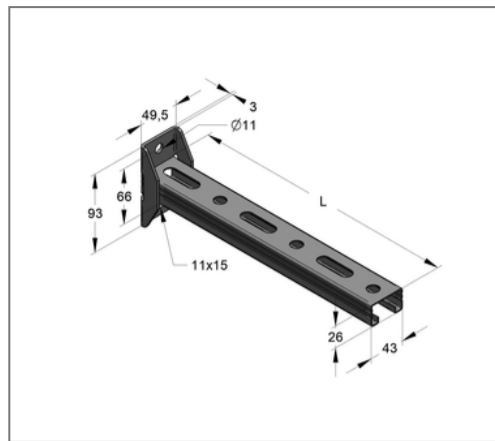

### Commercial details

Part no.	18035052501
EAN/GTIN	4250928456465
Packing unit	15 pcs
Quantity unit	pcs
Weight	0,841 kg/pc
Product group	02-083
Price unit	1

### QR code



### Specification

Application area	Console for the production of cantilever structures for the support of suspended and standing pipe loads.
------------------	---

### Technical data

Material	Steel
Surface	galvanized

### Product details

Width plate	49,5 mm
Length plate	93 mm
Hole distance	66 mm
Plate thickness	3 mm
Width profile	45 mm
Profile height	26 mm
Length console L	525 mm
Elongated hole plate	11x15 mm
load F1	0,47 kN
load F2	0,22 kN
load q0	0,9 kN/m
Profile thickness	1,5 mm