

## ■ Profile rail C-profile V2A 45 / 45 / 2 mm L= 6 m

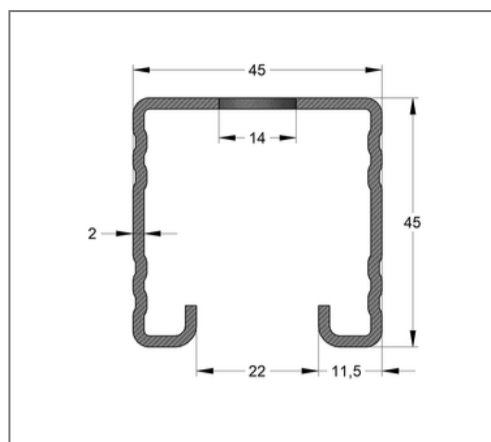
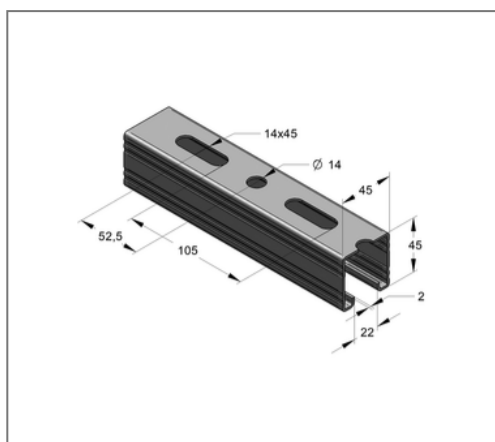

### Commercial details

Part no.	080005501
EAN/GTIN	4250928457301
Packing unit	30 m
Bundle	240 m
Quantity unit	m
Weight	2,50 kg/m
Product group	13-048
Price unit	1

### QR code



### Certification



### Specification

Specification	untoothed, perforated
---------------	-----------------------

### Technical data

Material	Stainless steel
Material type	V2A

### Product details

Width	45 mm
Height	45 mm
Thickness	2 mm
Length	6 m
Hole-Ø	14 mm
Elongated hole	14x45 mm
Area (least cross section of the profile rail)	2,86 cm <sup>2</sup>
Axial angular impulse I <sub>y</sub>	7,46 cm <sup>4</sup>
Axial angular impulse I <sub>z</sub>	10,38 cm <sup>4</sup>
Grid dimension	105,0 mm
Rail slot width	22 mm
Centroid distance e <sub>o</sub>	2,27 cm
Centroid distance e <sub>u</sub>	2,22 cm
Centroid distance e <sub>z</sub>	2,25 cm
Elastic limit	230 N/mm <sup>2</sup>
Radius of inertia i <sub>y</sub>	1,62 cm

### Remark

Notice	Full bundle, only
--------	-------------------

## Product details

Radius of inertia $i_z$	1,91 cm
Section modulus $W_Y$	3,28 cm <sup>3</sup>
Section modulus $W_Z$	4,61 cm <sup>3</sup>