

■ Hexagon screw EN ISO 4017 M16 x 30 mm hot-dip galv. FK 8.8

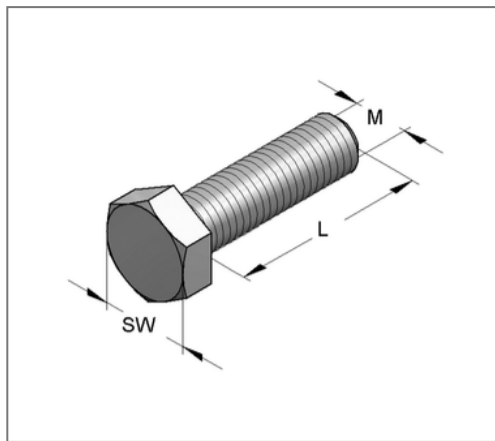
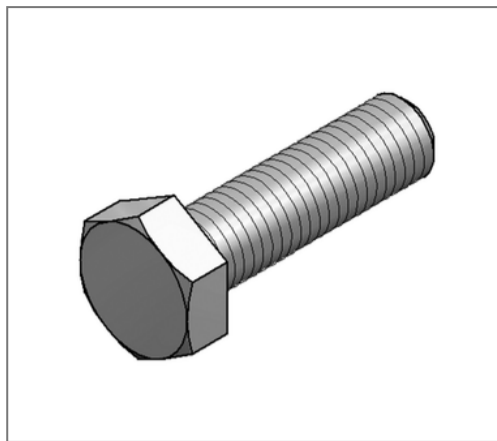

Commercial details

Part no.	3207630/fvz
EAN/GTIN	4250928457271
Packing unit	1 pcs
Quantity unit	pcs
Weight	0,0853 kg/pc
Product group	05-320
Price unit	100

QR code



Certification



Technical data

Material	Steel
Surface	hot-dip galvanized
Strength class	8.8

Product details

Thread M	M16
Length L	30 mm
Wrench size SW	24
Shape head	Hexagon head