

## ■ Hexagon screw EN ISO 4017 M16 x 60 mm hot-dip galv. FK 8.8

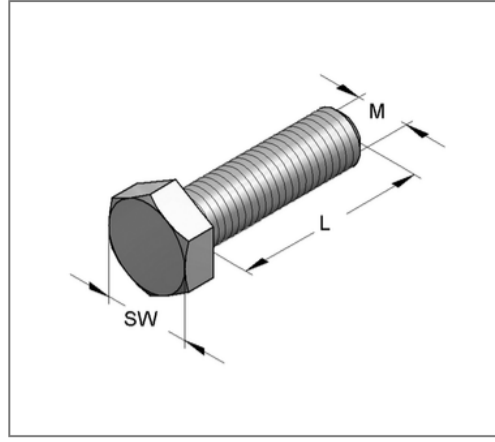
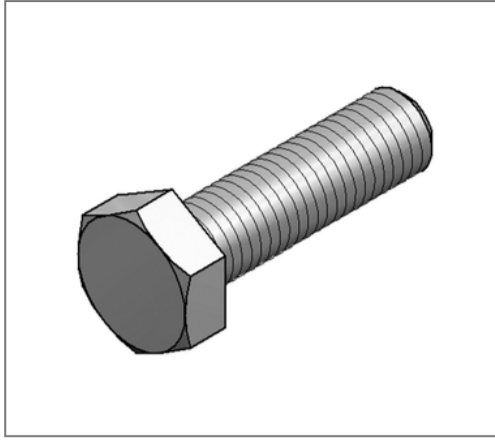

### Commercial details

Part no.	3207660/fvz
EAN/GTIN	4250928457288
Packing unit	50 pcs
Quantity unit	pcs
Weight	0,133 kg/pc
Product group	05-320
Price unit	100

### QR code



### Certification



### Technical data

Material	Steel
Surface	hot-dip galvanized
Strength class	8.8

### Product details

Thread M	M16
Length L	60 mm
Wrench size SW	24
Shape head	Hexagon head