

■ Carrier console with 1 brace L= 735 mm Profile 45/45

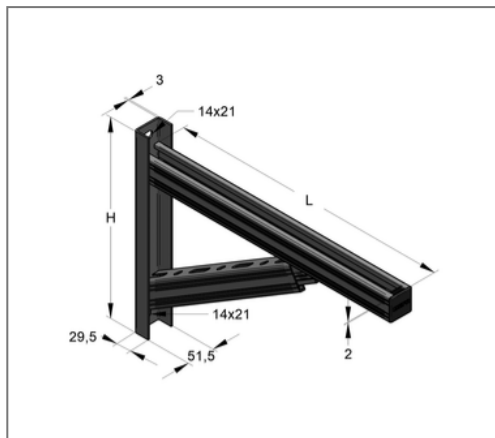

Commercial details

Part no.	180470736/fvz
EAN/GTIN	4250928459565
Packing unit	6 set
Quantity unit	set
Weight	4,73 kg/set
Product group	02-083
Price unit	1

QR code



Certification



Specification

Application	Console with welded strut as equipment base in the outdoor area.
Profile type	45/45
Delivery	with protective cap

Technical data

Material	Steel
Material type	S235
Surface	hot-dip galvanized

Product details

Höhe H	485 mm
Length L	735 mm
Thickness S	2 mm
Hole distance	439,5 mm
load F1	7,3 kN
load F2	2,6 kN