

■ U-bolt 139,7 mm M12 total height 225 mm

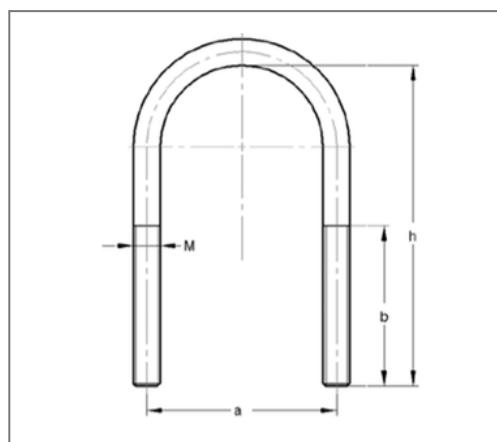

Commercial details

Part no.	050714001
EAN/GTIN	4250928463579
Packing unit	25 pcs
Quantity unit	pcs
Weight	0,394 kg/pc
Product group	01-050
Price unit	1

QR code



Specification

Application area	for direct installation of piping onto steel structures and suitable for push-through-assembling into profile rails. Suitable for sprinkler
------------------	---

Specification	similar to DIN 3570
---------------	---------------------

Technical data

Material	Steel
Material type	S235
Surface	galvanized

Product details

Center distance a	152 mm
Height h	225 mm
Outside pipe diameter inch	5 inch
Thread M	M12
Length thread b	95 mm
Outer pipe diameter	139,7 mm

Remark

Notice	without nut
--------	-------------