

■ **SIGNUM LP50 Packing unit: 1152 m 27 / 50 / 1,5 mm L= 2 m pre-galv.**

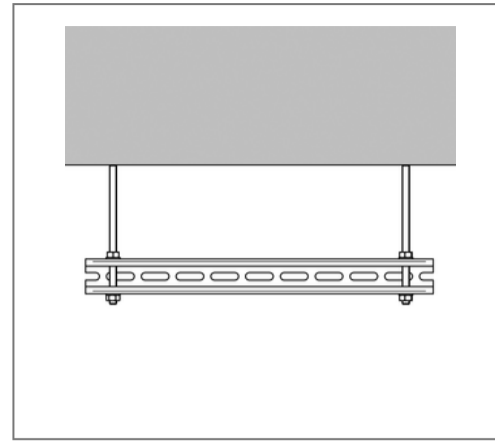
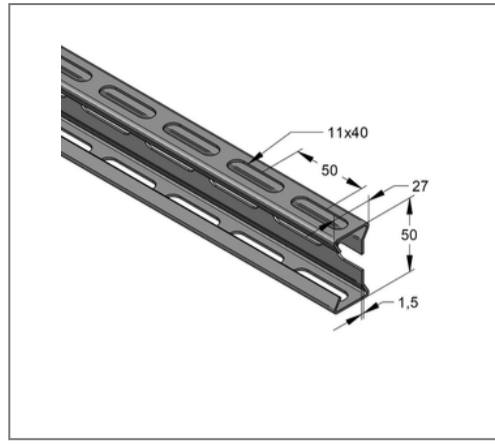
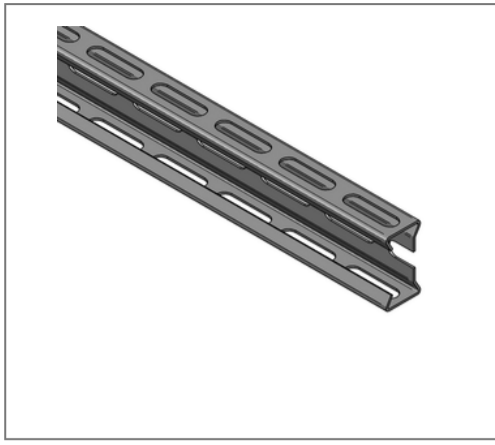

Commercial details

Part no.	0800201-1152
EAN/GTIN	4250928468031
Packing unit	1152 m
Bundle	216 m
Quantity unit	m
Weight	1,11 kg/m
Product group	08-985
Price unit	1

QR code



Certification



Technical data

Material	Steel
Material type	S250
Surface	pre-galvanized

Product details

Width	27 mm
Height	50 mm
Thickness	1,5 mm
Length	2 m
Elongated hole	11x40 mm
Area (least cross section of the profile rail)	1,29 cm ²
Axial angular impulse I _y	5,01 cm ⁴
Axial angular impulse I _z	1,26 cm ⁴
Grid dimension	50 mm
Rail slot width	11 mm
Centroid distance e _o	2,5 cm
Centroid distance e _u	2,5 cm
Centroid distance e _z	1,54 cm
Elastic limit	250 N/mm ²
Radius of inertia i _y	1,97 cm
Radius of inertia i _z	1,37 cm
Section modulus W _y	2,01 cm ³
Section modulus W _z	0,87 cm ³